



Thomas Dudley Foundry
Complete casting solutions

UTILITY CASTINGS RANGE
PRODUCT SPECIFICATION GUIDE



PRODUCT SPECIFICATION GUIDE

WELCOME

The new Thomas Dudley Foundry Utility Castings Range Product Specification Guide, has been designed to provide an easy to use overview and technical specifications for our products.

Thomas Dudley provides a comprehensive portfolio of castings and is able to call upon unrivalled expertise in design, development and manufacturing.

Having been a foundry since 1920, we also have the technical know how to identify and work with market-leading overseas foundries. We partner with these to source high quality larger castings which are outside of the scope of our production.

THE THOMAS DUDLEY DIFFERENCE A UNIQUELY FLEXIBLE, PEOPLE DRIVEN ORGANISATION

- Foundry in the UK since 1920
- Family owned and managed business
- Experienced and award winning management teams
- Investing heavily in the latest state-of-the-art technology
- Exceptional quality control is employed throughout the business
- Advanced processes to offer assured casting integrity
- Castings comply 100% with British Standards; exceeding EU and KM standards
- Financially stable source of supply
- Heavy duty manhole covers and drain grates that are guaranteed to pass the required load tests
- Commitment to quality; offering on-site testing of customers existing castings free of charge to allow comparison of performance
- Disamatic, Kunkel Wagner and airset moulding lines provide the ability to select the perfect platform for each casting product

Our extensive expertise, state-of-the-art technology and exceptional quality control enable the Thomas Dudley range to be specified with confidence.

Get in touch with our dedicated specification team at:
foundrysales@thomasdudley.co.uk



- 4 FINDING THE RIGHT PRODUCT
- 5 STANDARDS AND LOAD CLASSES
- 7 CAN YOUR CASTINGS HANDLE THE PRESSURE
- 8 BETTER YOUR DESIGNS
- 10 UNIQUE FEATURES OF THOMAS DUDLEY
 - 11 PATENTED / PATENT PENDING
- REMOVABLE HINGE
- 12 GULLY GRATES AND FRAMES
 - 13 B125KM
 - 14 C250KM
- 15 SINGLE GRATINGS AND FRAMES
 - 16 C250KM
 - 17 D400KM
- 19 DOUBLE TRIANGULAR GRATINGS AND FRAMES
 - 20 D400KM
 - 21 E600KM
 - 22 F900KM
- 23 SINGLE PIECE AND SOLID TOP COVERS AND FRAMES
 - 24 A15KM
 - 25 B125KM
 - 26 D400KM
- 27 DOUBLE TRIANGULAR COVERS AND FRAMES
 - 28 D400KM
 - 29 D400KM DROP IN
 - 30 E600KM
 - 31 F900KM
- 32 MULTI-PART DOUBLE TRIANGULAR COVERS AND FRAMES
 - 33 D400KM
 - 34 E600KM
 - 35 F900KM
- 36 OTHER DRAINAGE CASTINGS AND TOOLS
- 42 SURFACE BOXES
- 45 ALUMINIUM DOUBLE SEALED DS-LINE
- 47 ALUMINIUM TRIPLE SEALED TSL-PRO-LINE

FINDING THE RIGHT PRODUCT

Designs vary between manufacturers and are often changed so you cannot simply replace the lid of a broken or missing cover as you have difficulty finding a lid to fit an existing frame.

We work on what is known as the “clear opening” size. This is the size of the hole you wish to cover i.e. the hole in the cover slab or internal measurement of the brick or plastic chamber. Other dimensions such as the lid or frame dimensions can vary between manufacturers. The clear opening is always the same.

For gully grates - we need to know the size of the gully pot you are planning on using.

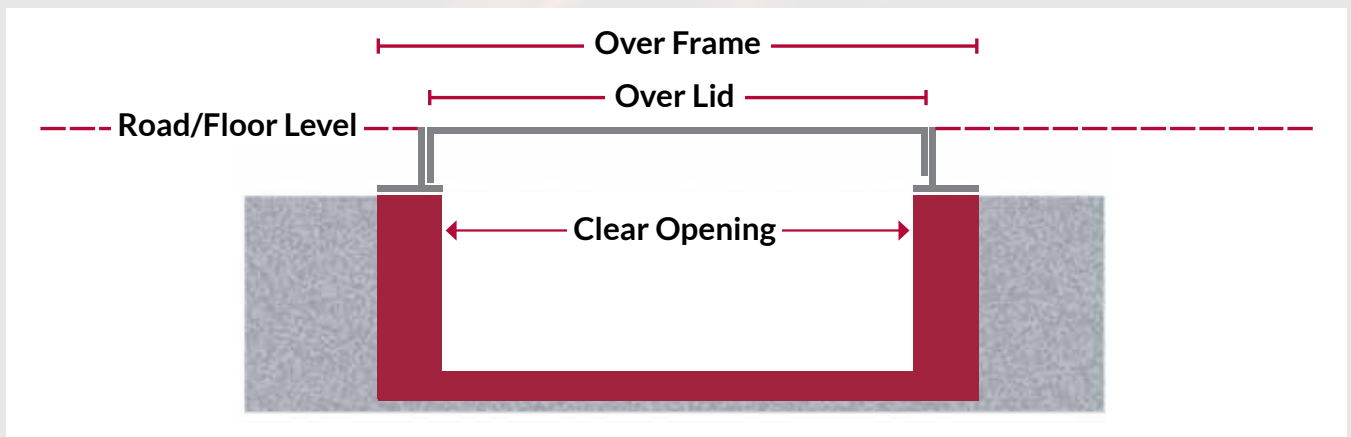

STANDARDS AND LOAD CLASSES

There are three main third party standards which apply to utility castings and determine key criteria, such as load bearing ability.

These are:

- Level 1. European Standard BS EN 124-2:2015
- Level 2. British Standards Institute (BSI) 'Kitemark'
- Level 3. Highways Authority Advice Note HA 104/09



COMPLIES WITH
BSEN 124-2



CERTIFIED
BY BSI



COMPLIES WITH
HA 104/09

EUROPEAN STANDARD BS EN 124-2:2015.

Access covers and gully grates installed in the UK should meet the requirements of the European Standard BS EN 124-2:2015.

This standard divides access covers and gully grates into a number of classes by static test load. It also categorises the various places where they may be installed from Group 1, the least demanding environment, through to Group 6, the most demanding. It provides guidance on the minimum class to be used against each installation group.

STANDARDS AND LOAD CLASSES

The below table explains how weight loadings work however if you are still unsure of what you need then please give us a call and we will be happy to help and talk through your requirements with you.

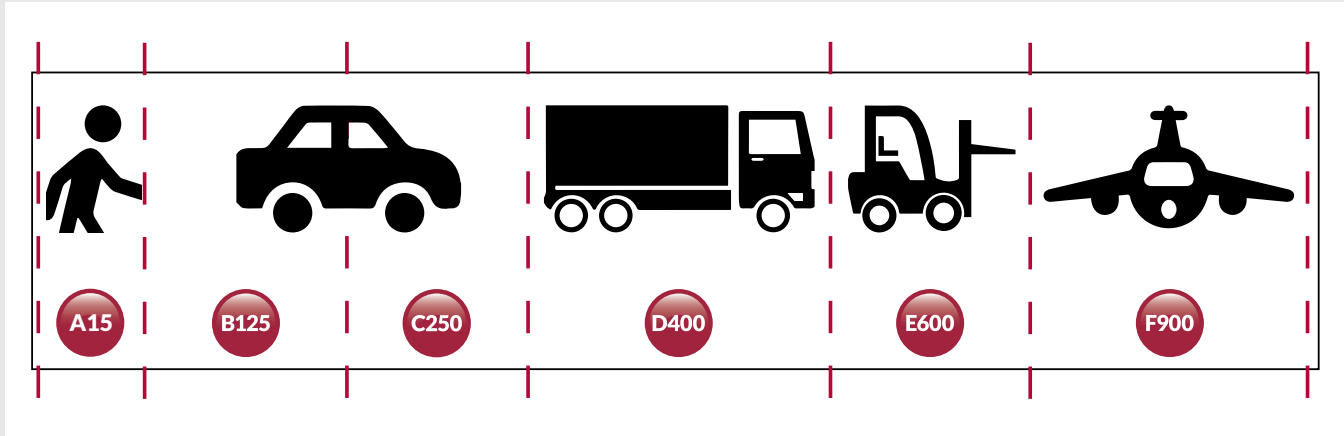

A15	Areas which can only be used by pedestrians and cyclists.
B125	Footways, pedestrian and comparable areas, car parks or car parking decks.
C250	For gully tops installed in the area of kerbside channels of roads which when measured from the kerb edge, extend a maximum of 0.5m into the carriageway and a maximum of 0.2m into the footway.
D400	Carriageways or roads (including pedestrian streets), hard shoulders and parking areas, for all types of road vehicles.
E600	Areas imposing high wheel loads, e.g. docks, aircraft pavements.
F900	Areas imposing particularly high wheel loads, e.g. aircraft pavements.

Group 1: Minimum Class A15

Access covers and gratings capable of withstanding a 15kN test load. For use in areas where only pedestrians have access.

Group 2: Minimum Class B125

Access covers and gratings capable of withstanding a 125kN test load. For use in car parks and pedestrian areas where only occasional vehicular access is likely.

Group 3: Minimum Class C250

Access covers and gratings capable of withstanding a 250kN test load. For use in car parks, forecourts, industrial sites and areas with slow moving traffic also in highway locations up to 500mm from the kerb and up to 200mm into the verge, excluding motorways.

Group 4: Minimum Class D400

Access covers and gratings capable of withstanding a 400kN test load. For use in areas where cars and lorries have access, including carriageways, hard shoulders and pedestrian areas.

Group 5: Minimum Class E600

Access covers and gratings capable of withstanding a 600kN test load. For use in areas where high wheel loads are imposed such as loading areas, docks or aircraft pavements.

Group 6: Minimum Class F900

Access covers and gratings capable of withstanding a 900kN test load. For use in areas where particularly high wheel loads are imposed such as aircraft pavements.

STANDARDS AND LOAD CLASSES

BSI KITEMARK CERTIFICATION

The BSI Kitemark BS 7903:1997 applies to products up to 1000mm c/o, as defined by EN 124-2 (see page 4). As a guide, the BSI standard is around 10% higher than BS EN 124-2.

HIGHWAYS AUTHORITY ADVICE NOTE HA 104/09

The Highways Authority provides additional guidelines for road chamber top and gully top installations in trunk roads and motorways. These more rigorous requirements are intended to meet the demands of heavily trafficked areas and high tonnage commercial vehicles. The requirements include:

- The installation of higher category covers and frames; E600 should be considered in all applications subjected to over 1,500 commercial vehicles per day.
- 150mm depth
- Depth of insertion to be no less than 80mm

Though a product may be specified to comply with HA guidelines, the guidelines come in the form of an Advisory Note and are not enforced as a standard.

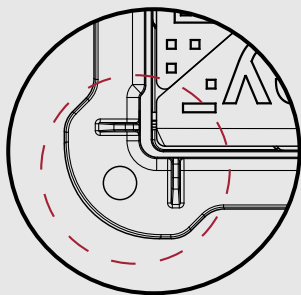

- 1**
Increased bearing pressure of the frame.

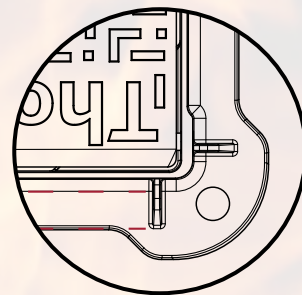

- 2**
The Flange should be at least **5mm thick** and **50-120mm wide**

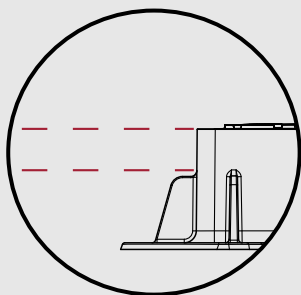

- 3**
Gussets must be below the top of the frame by at least **25mm** and should conform to BS7903.

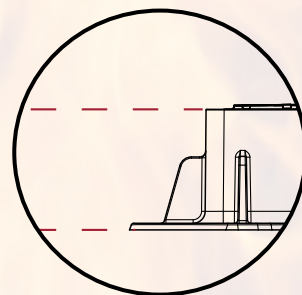

- 4**
Frames fitted in trunk roads and motorways should be at least **150mm deep**.

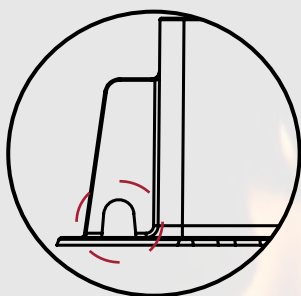

- 5**
Balanced lifting must be incorporated into frames which are heavier than **15Kg**.

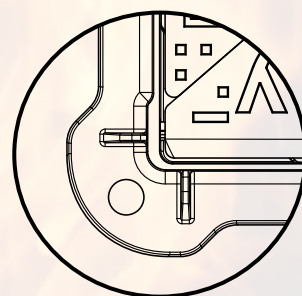

- 6**
Frames should allow for a higher level of mortar adhesion.

CAN YOUR CASTINGS HANDLE THE PRESSURE?

MARKET-LEADING CASTINGS THAT EXCEED EUROPEAN AND KM STANDARDS

Thomas Dudley castings are manufactured to provide assured performance. Unlike many inferior products that break at loads way below those specified by British Standards, our heavy duty manhole covers and drain grates are guaranteed to 100% pass the required load tests. We're so committed to quality that we'll even test your existing castings free of charge to allow you to see how our castings compare.



*email: foundrysales@thomasdudley.co.uk

**FREE LOAD
TEST**

*see if they meet
the standard

BETTER BY DESIGN

Thomas Dudley utility castings are engineered to deliver assured quality and performance.

Our vastly experienced UK team has employed state-of-the-art design and development technology to produce a range of castings that incorporates a host of innovative features. Many of these features are patent protected and help to make castings quicker, easier and safer to install and use.

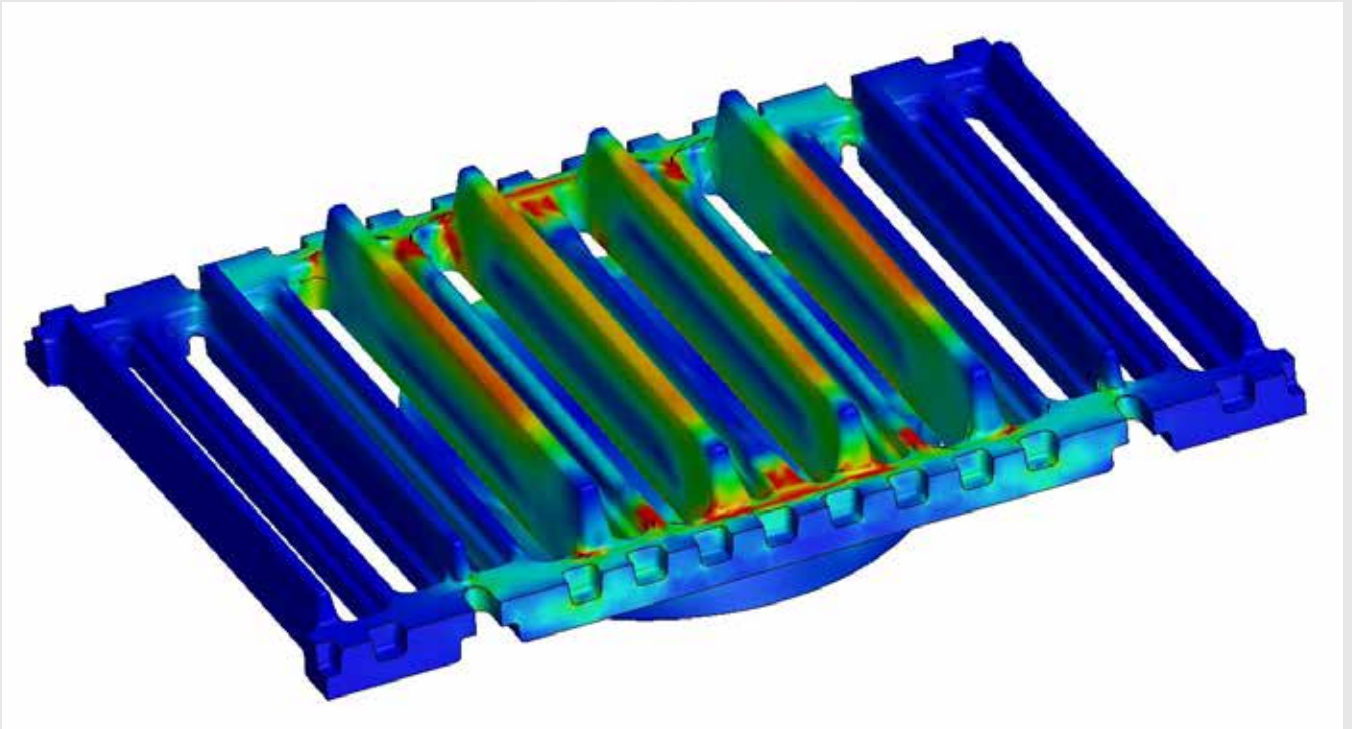

In addition, our manhole covers, gratings and surface boxes are up to 25% lighter than their traditional counterparts. Here, our ground-breaking designs have enabled casting weight to be reduced without compromising strength and durability.

Instead, Thomas Dudley engineers have taken time to design castings that offer assured performance and comply fully with and exceed British Standards. Stress testing simulation software has been used to pro-actively strengthen those parts of a casting that are subjected to most pressure in the field. We have also developed robust testing methodologies and are the only UK foundry to undertake testing in accordance with BS EN 124 - 2.

We have the expertise to re-engineer existing customer castings. These can be tested free of charge to establish whether they comply with British Standards. We can then reconfigure designs to improve performance whilst reducing weight and costs

BEFORE

Casting broke at 458 KN in load test



AFTER

Casting broke at 461 KN in load test

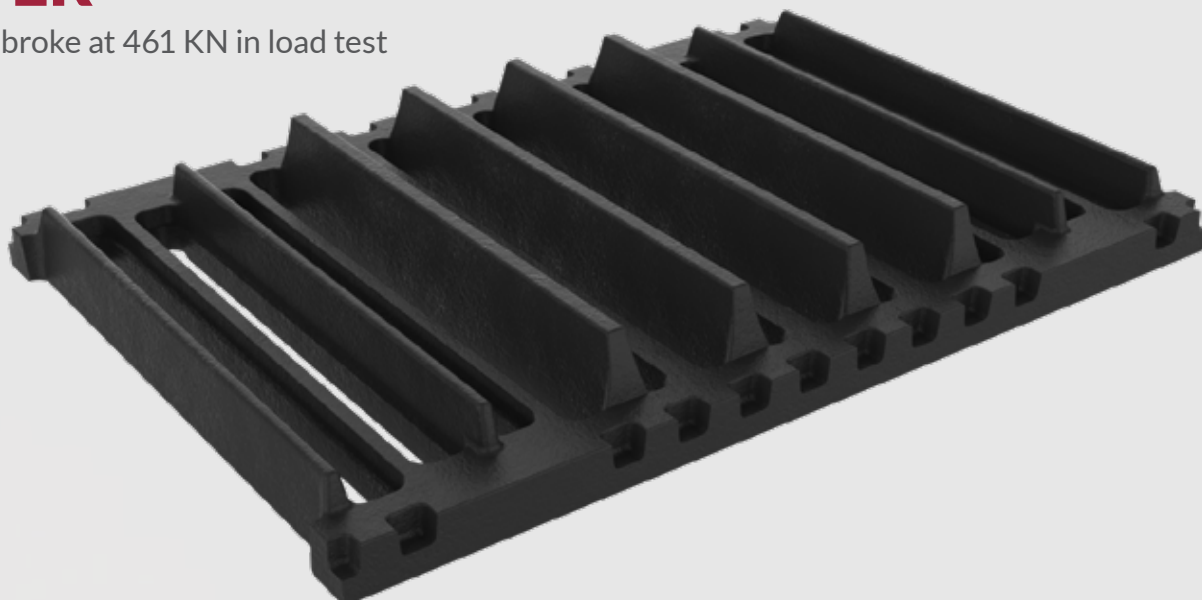

UNIQUE FEATURES OF THOMAS DUDLEY



UK designed castings, quality assured and Kitemarked



Flexibility and design expertise



Next day despatch / collection



TD brand D400 loadings and above only available as HA104/09 compliant as standard, fully flanged and 80mm min depth of insertion

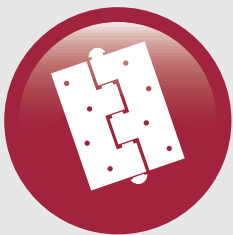

Patented / patent pending unique design features; interference hinge for gratings and lift out hinge for covers, providing superior stability, quiet operation and safer operation



Free load testing available; we are one of the the only Foundries in the UK that can test to BS EN 124-2:2015

PATENTED/PATENT PENDING REMOVABLE HINGE



UNIQUE FEATURES

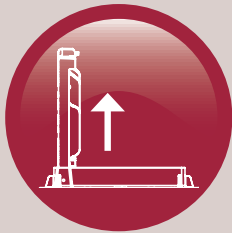

BENEFITS

- ✓ Patented / patent pending unique design features; lift out covers providing 135° hinging giving superior site safety and one man operation for virtually all sizes
- ✓ Option to remove covers completely provides additional safety for man entry requirements



GULLY GRATINGS & FRAMES

FLAT AND DISHED



FEATURES INC IN THE RANGE



COMPLIES WITH
BS EN 124-2



CERTIFIED BY BSI

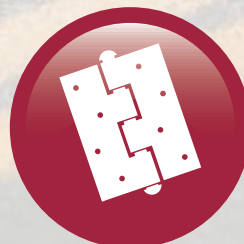

INTERFERENCE
HINGE



LOCK & NON-LOCK
VERSIONS

B125KM DUCTILE IRON HINGED GULLY GRATING & FRAME

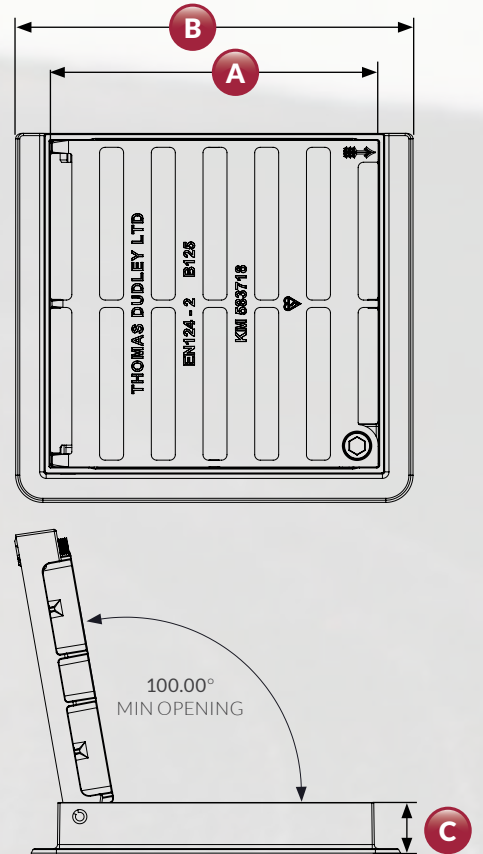

KEY FEATURES



COMPLIES WITH
BS EN 124-2



INTERFERENCE
HINGE



SUITS CLASS
B125 APPLICATIONS



SECURE, TAMPER-PROOF
LOCK & NON-LOCK
VERSIONS

BENEFITS

- ✓ Complies fully with BS EN 124-2:2015 Standard - suitable for intensity of traffic in Class B125 applications
- ✓ Engineered from quality assured ductile iron
- ✓ Tight fit, non rattle interference hinge
- ✓ Secure, tamper-proof lock and non-lock versions

CLEAR OPENING (A) MM	OVER FRAME (B) MM	TYPE	FLANGE DESIGN	DEPTH (C) MM	WATERWAY	LOCK	STYLE	CODE
225x225	290x264	GULLY GRATE	3 - SIDE	50	242CM ²		FLAT	333009
225x225	290x264	GULLY GRATE	3 - SIDE	50	242CM ²	✓	FLAT	334558
225x225	290x264	GULLY GRATE	3 - SIDE	50	244CM ²		DISHED	332131
225x225	290x264	GULLY GRATE	3 - SIDE	50	244CM ²	✓	DISHED	334559
300x300	365x339	GULLY GRATE	3 - SIDE	50	400CM ²		FLAT	333615
300x300	365x339	GULLY GRATE	3 - SIDE	50	400CM ²	✓	FLAT	334560
300x300	365x339	GULLY GRATE	3 - SIDE	50	402CM ²		DISHED	332133
300x300	365x339	GULLY GRATE	✓ 3 - SIDE	50	402CM ²	✓	DISHED	334561

C250KM DUCTILE IRON HINGED GULLY GRATING & FRAME

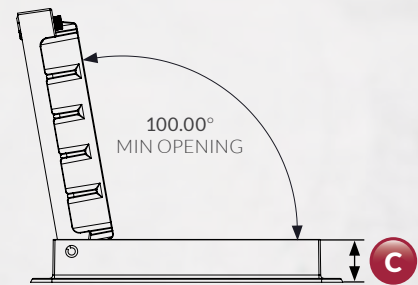
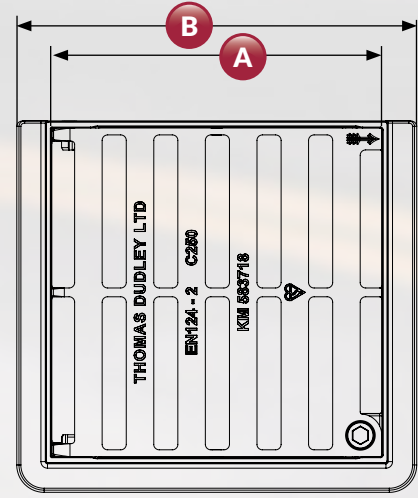

KEY FEATURES



COMPLIES WITH
BS EN 124-2



INTERFERENCE
HINGE



SUITS CLASS
C250 APPLICATIONS



SECURE, TAMPER-PROOF
LOCK & NON-LOCK
VERSIONS

BENEFITS

- ✓ Complies fully with BS EN 124-2:2015 Standard- suitable for intensity of traffic in Class C250 applications
- ✓ Engineered from quality assured ductile iron
- ✓ Tight fit, non rattle interference hinge
- ✓ Secure, tamper-proof lock and non-lock versions

CLEAR OPENING (A) MM	OVER FRAME (B) MM	TYPE	FLANGE DESIGN	DEPTH (C) MM	WATERWAY	LOCK	STYLE	CODE
225x225	290x264	GULLY GRATE	3-SIDE	50	239CM ²		FLAT	333613
225x225	290x264	GULLY GRATE	3-SIDE	50	239CM ²	✓	FLAT	334562
225x225	290x264	GULLY GRATE	3-SIDE	50	236CM ²		DISHED	333611
225x225	290x264	GULLY GRATE	3-SIDE	50	236CM ²	✓	DISHED	334563
300x300	365x339	GULLY GRATE	3-SIDE	50	403CM ²		FLAT	333584
300x300	365x339	GULLY GRATE	3-SIDE	50	403CM ²	✓	FLAT	334564
300x300	365x339	GULLY GRATE	3-SIDE	50	399CM ²		DISHED	332798
300x300	365x339	GULLY GRATE	3-SIDE	50	399CM ²	✓	DISHED	334565

SINGLE GRATINGS & FRAMES

FLAT AND DISHED

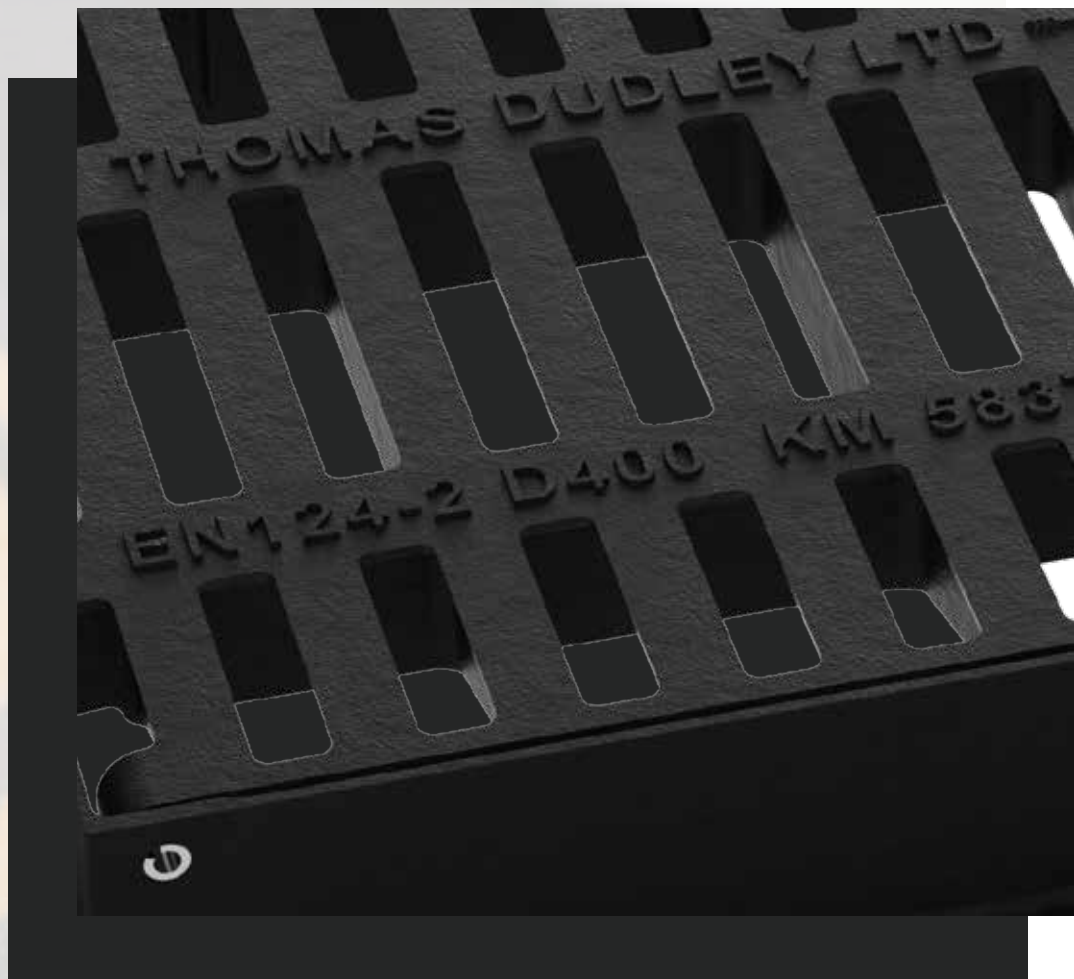

FEATURES INC IN THE RANGE



COMPLIES WITH
BS EN 124-2

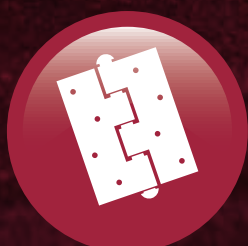

INTERFERENCE
HINGE



LOCK & NON-LOCK
VERSIONS



COMPLIES WITH UK
HIGHWAYS AUTHORITY

C250KM DUCTILE IRON HINGED GRATING & FRAME

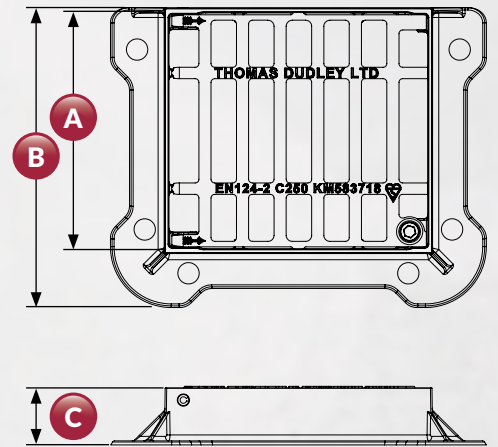

KEY FEATURES



COMPLIES WITH
BS EN 124-2



INTERFERENCE
HINGE



SUITS CLASS
C250 APPLICATIONS



SECURE, TAMPER-PROOF
LOCK & NON-LOCK
VERSIONS

BENEFITS

- ✓ Complies fully with BS EN 124-2:2015 Standard- suitable for intensity of traffic in Class C250 applications
- ✓ Engineered from quality assured ductile iron
- ✓ Tight fit, non rattle interference hinge
- ✓ Secure, tamper-proof lock and non-lock versions

CLEAR OPENING (A) MM	OVER FRAME (B) MM	TYPE	FLANGE DESIGN	DEPTH (C) MM	WATERWAY	LOCK	STYLE	CODE
340x310	494x394	GRATE & FRAME	3 - SIDE	75	602CM ²		FLAT	330830
340x310	494x394	GRATE & FRAME	3 - SIDE	75	602CM ²	✓	FLAT	330973

D400KM DUCTILE IRON HINGED GRATING & FRAME

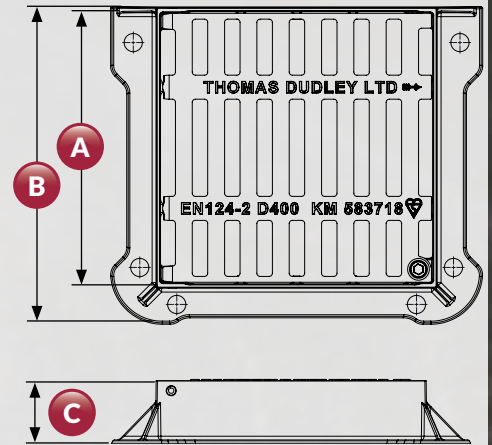

KEY FEATURES



COMPLIES WITH
BS EN 124-2



INTERFERENCE
HINGE



SUITS CLASS
D400 APPLICATIONS



COMPLIES WITH UK
HIGHWAYS AUTHORITY
HA 104/09

BENEFITS

- ✓ Complies fully with BS EN 124-2:2015 and Highways Authority HA 104/09 Standard - suitable for intensity of traffic in Class D400 applications
- ✓ Engineered from quality assured ductile iron
- ✓ All tight fit, non rattle interference hinged (inc double triangular non-rock) as standard
- ✓ Available with secure, tamper-proof lock and non-lock versions

* CLEAR OPENING (A) MM	OVER FRAME (B) MM	TYPE	FLANGE DESIGN	DEPTH (C) MM	WATERWAY	LOCK	STYLE	CODE
365x310	519x395	GRATE & FRAME	3 - SIDE	100	400CM ²	✓	FLAT	330976
365x310	519x395	GRATE & FRAME	3 - SIDE	100	400CM ²		FLAT	330829
390x315	540x466	GRATE & FRAME	4 - SIDE	100	730CM ²		FLAT	334566
390x315	540x466	GRATE & FRAME	4 - SIDE	100	730CM ²	✓	FLAT	334230
390x315	540x466	GRATE & FRAME	4 - SIDE	100	740CM ²		DISHED	334567
390x315	540x466	GRATE & FRAME	4 - SIDE	100	740CM ²	✓	DISHED	334175

*TABLE CONTINUED OVERLEAF

D400KM DUCTILE IRON HINGED GRATING & FRAME CONTINUED

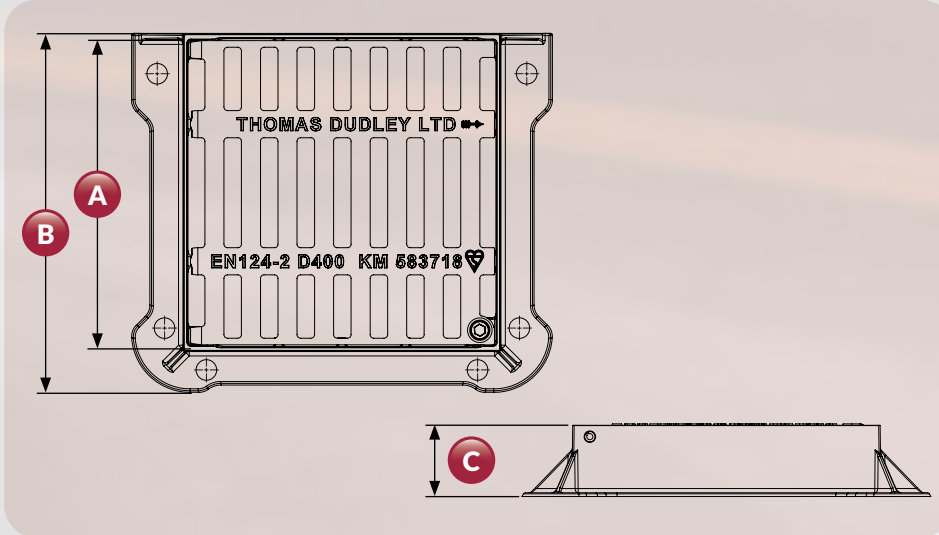

KEY FEATURES



PEDESTRIAN MESH



INCREASED WATERWAY

CLEAR OPENING (A) MM	OVER FRAME (B) MM	TYPE	FLANGE DESIGN	DEPTH (C) MM	WATERWAY	LOCK	STYLE	CODE
420x420	574x490	GRATE & FRAME	3-SIDE	100	650CM ²		FLAT	330826
420x420	574x490	GRATE & FRAME	3-SIDE	150	650CM ²		FLAT	332672
420x420	574x490	GRATE & FRAME	3-SIDE	100	650CM ²	✓	FLAT	333692
420x420	574x490	GRATE & FRAME	3-SIDE	150	650CM ²	✓	FLAT	334568
420x420	574x490	PEDESTRIAN MESH	3-SIDE	100	517CM ²		FLAT	332476
420x420	574x490	PEDESTRIAN MESH	3-SIDE	150	517CM ²		FLAT	334569
420x420	574x490	PEDESTRIAN MESH	3-SIDE	100	517CM ²	✓	FLAT	334570
420x420	574x490	PEDESTRIAN MESH	3-SIDE	150	517CM ²	✓	FLAT	334571
420x420	574x490	INCREASED WATERWAY	3-SIDE	100	1243CM ²		FLAT	333714
420x420	574x490	INCREASED WATERWAY	3-SIDE	150	1243CM ²		FLAT	334572
420x420	574x490	INCREASED WATERWAY	3-SIDE	100	1243CM ²	✓	FLAT	333711
420x420	574x490	INCREASED WATERWAY	3-SIDE	150	1243CM ²	✓	FLAT	333823
430x370	574x505	GRATE & FRAME	3-SIDE	100	599CM ²		FLAT	330827
430x370	574x505	GRATE & FRAME	3-SIDE	100	599CM ²	✓	FLAT	332765

DOUBLE TRIANGULAR GRATINGS AND FRAMES



FEATURES INC IN THE RANGE



COMPLIES WITH
BS EN 124-2

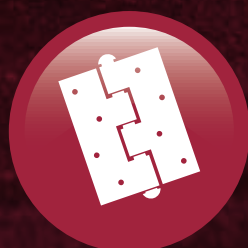

INTERFERENCE
HINGE



LOCK & NON-LOCK
VERSIONS



COMPLIES WITH UK
HIGHWAYS AUTHORITY

D400KM DUCTILE IRON HINGED DOUBLE TRIANGULAR GRATING & FRAME

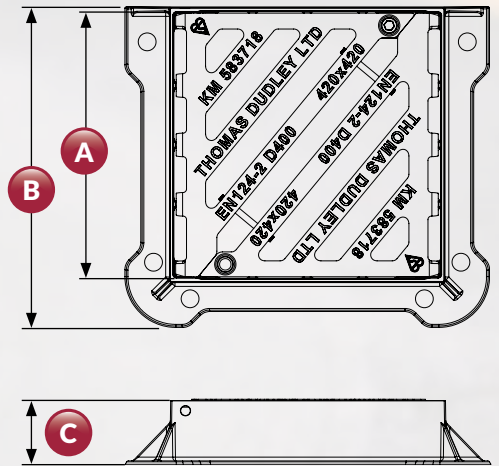

KEY FEATURES



COMPLIES WITH
BS EN 124-2



INTERFERENCE
HINGE



SUITS CLASS
D400 APPLICATIONS



COMPLIES WITH UK
HIGHWAYS AUTHORITY
HA 104/09

BENEFITS

- ✓ Complies fully with BS EN 124-2:2015 and Highways Authority HA 104/09 Standard - suitable for intensity of traffic in Class D400 applications
- ✓ Engineered from quality assured ductile iron
- ✓ All tight fit, non rattle interference hinged (inc double triangular non-rock) as standard
- ✓ Available with secure, tamper-proof lock and non-lock versions
- ✓ Increased waterway available
- ✓ Lift out covers for 600 x 600 and above, providing 135° hinging giving superior site safety and one man operation

CLEAR OPENING (A) MM	OVER FRAME (B) MM	TYPE	FLANGE DESIGN	DEPTH (C) MM	WATERWAY	LOCK	STYLE	CODE
* 420x420	590x460	GRATE & FRAME	3- SIDE	100	716CM ²		FLAT	330828
* 420x420	590x460	GRATE & FRAME	3- SIDE	100	716CM ²	✓	FLAT	333692
450x450	604x535	GRATE & FRAME	3- SIDE	100	852CM ²		FLAT	331307
450x450	604x535	GRATE & FRAME	3- SIDE	100	852CM ²	✓	FLAT	334573
600x600	675x750	INCREASED WATERWAY	4- SIDE	100	2500CM ²		FLAT	333018
600x600	675x750	INCREASED WATERWAY	4- SIDE	150	2500CM ²		FLAT	334574
600x600	675x750	INCREASED WATERWAY	4- SIDE	100	2500CM ²	✓	FLAT	333018
600x600	675x750	INCREASED WATERWAY	4- SIDE	150	2500CM ²	✓	FLAT	334575

*C250 also available, please enquire

E600KM DUCTILE IRON HINGED DOUBLE TRIANGULAR GRATING & FRAME

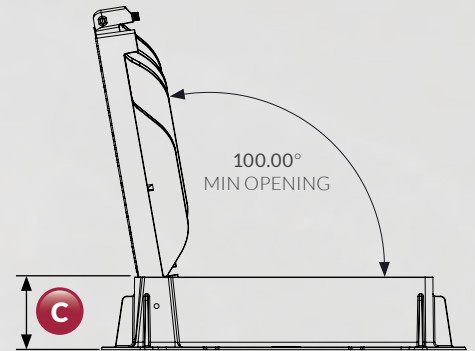
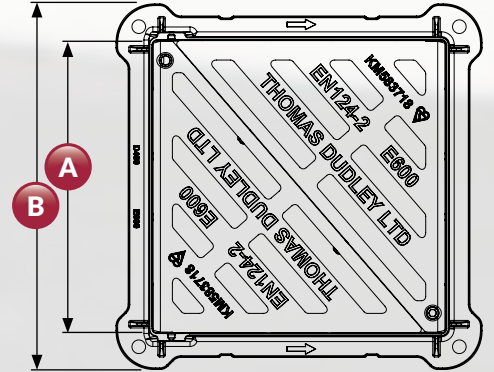
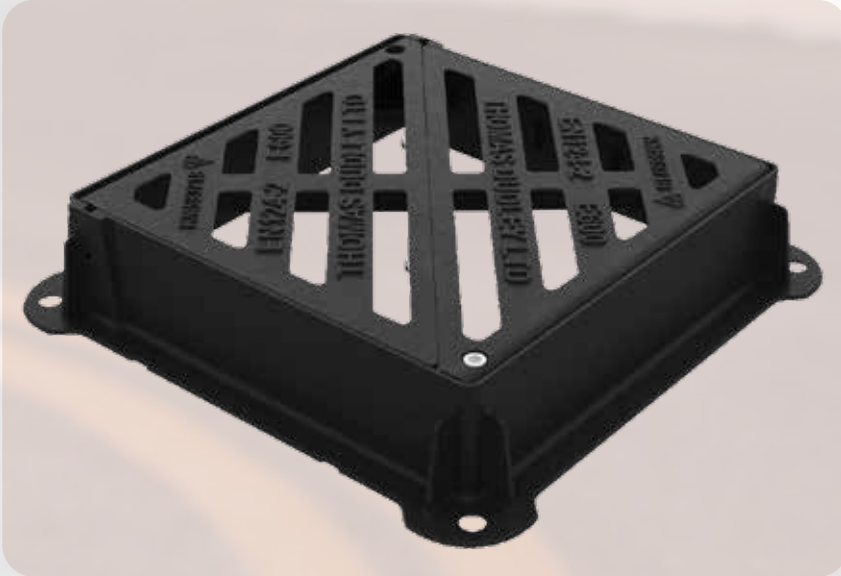

KEY FEATURES



COMPLIES WITH
BS EN 124-2



INTERFERENCE
HINGE



SUITS CLASS
E600 APPLICATIONS



COMPLIES WITH UK
HIGHWAYS AUTHORITY
HA 104/09

BENEFITS

- ✓ Complies fully with BS EN 124-2:2015 and Highways Authority HA 104/09 Standard - suitable for intensity of traffic in Class E600 applications
- ✓ Engineered from quality assured ductile iron
- ✓ All tight fit, non rattle interference hinged (inc double triangular non-rock) as standard
- ✓ Available with secure, tamper-proof lock and non-lock versions
- ✓ Lift out covers providing 135° hinging giving superior site safety and one man operation

CLEAR OPENING (A) MM	OVER FRAME (B) MM	TYPE	FLANGE DESIGN	DEPTH (C) MM	WATERWAY	LOCK	STYLE	CODE
600x600	754x754	GRATE & FRAME	4-SIDE	150	1048CM ²	✓	FLAT	334576
600x600	754x754	GRATE & FRAME	4-SIDE	150	1048CM ²		FLAT	334326

F900KM DUCTILE IRON HINGED DOUBLE TRIANGULAR GRATING & FRAME

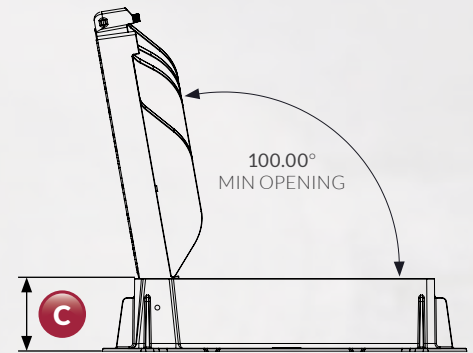
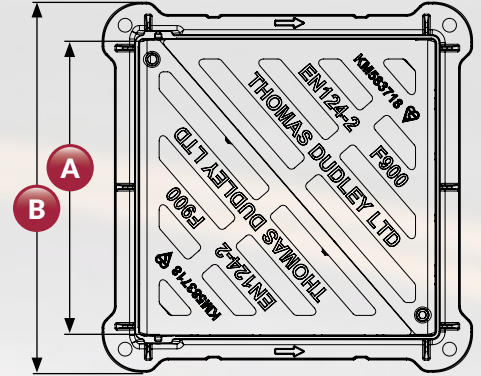

KEY FEATURES



COMPLIES WITH
BS EN 124-2



INTERFERENCE
HINGE



SUITS CLASS
F900 APPLICATIONS



COMPLIES WITH UK
HIGHWAYS AUTHORITY
HA 104/09

BENEFITS

- ✓ Complies fully with BS EN 124-2:2015 and Highways Authority HA 104/09 Standard - suitable for intensity of traffic in Class F900 applications
- ✓ Engineered from quality assured ductile iron
- ✓ All tight fit, non rattle interference hinged (inc double triangular non-rock) as standard
- ✓ Available with secure, tamper-proof lock and non-lock versions
- ✓ Lift out covers providing 135° hinging giving superior site safety and one man operation

CLEAR OPENING (A) MM	OVER FRAME (B) MM	TYPE	FLANGE DESIGN	DEPTH (C) MM	WATERWAY	LOCK	STYLE	CODE
600x600	754x754	GRATE & FRAME	4 - SIDE	150	1048CM ²	✓	FLAT	334577
600x600	754x754	GRATE & FRAME	4 - SIDE	150	1048CM ²		FLAT	334327

SINGLE PIECE / SOLID TOP COVERS AND FRAMES



FEATURES INC IN THE RANGE



COMPLIES WITH
BS EN 124-2



CERTIFIED
BY BSI



SLIP
RESISTANT



SNAP
LOCK

A15KM DUCTILE IRON SOLID TOP COVER & FRAME



KEY FEATURES

A15

SUITS CLASS
A15 APPLICATIONS

CLEAR OPENING (A) MM	OVER FRAME (B) MM	DEPTH (C) MM	CODE

BENEFITS



B125KM DUCTILE IRON SOLID TOP COVER & FRAME

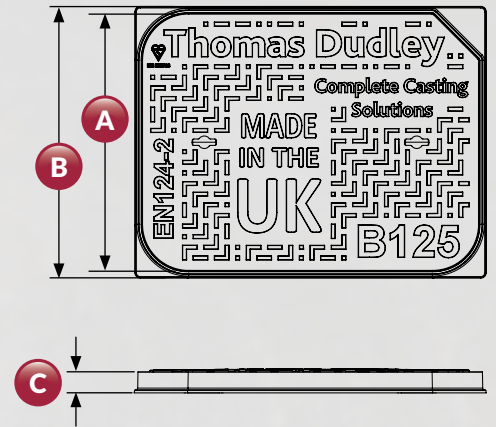

KEY FEATURES



COMPLIES WITH
BS EN 124-2



CERTIFIED
BY BSI



SUITS CLASS
B125 APPLICATIONS



SLIP RESISTANT

CLEAR OPENING (A) MM	OVER FRAME (B) MM	DEPTH (C) MM	CODE
300x300	368x368	40	333608
320 DIA	410 DIA	50	334390
450x450	518x518	40	332754
450x450	515x515	70	334395
450 DIA (A15KM)	550 DIA (A15KM)	40 (A15KM)	330825 (334392)
600x450	662x512	40	330824
600x450	705x555	75	321859
600x600	668x668	40	330934
600 DIA	700x700	75	330944
675x675	737x737	40	330935
750x450	818x550	50	TBC
750x600	818x668	40	330939
750x750	811x811	40	330936
900x600	968x668	40	330938
900x900	968x968	40	330937
1000x750	1180x820	50	TBC
1220x675	1286x737	40	334578

BENEFITS

- ✓ Complies fully with BS EN 124-2:2015
- ✓ Engineered from quality assured ductile iron
- ✓ Unique, slip resistant Thomas Dudley drain covers tread pattern

D400KM DUCTILE IRON COVER & FRAME

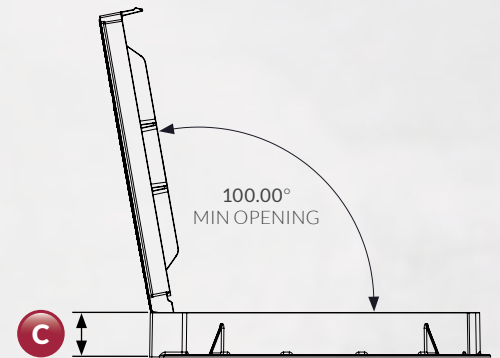
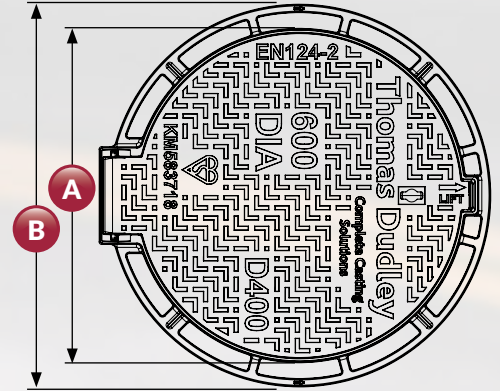
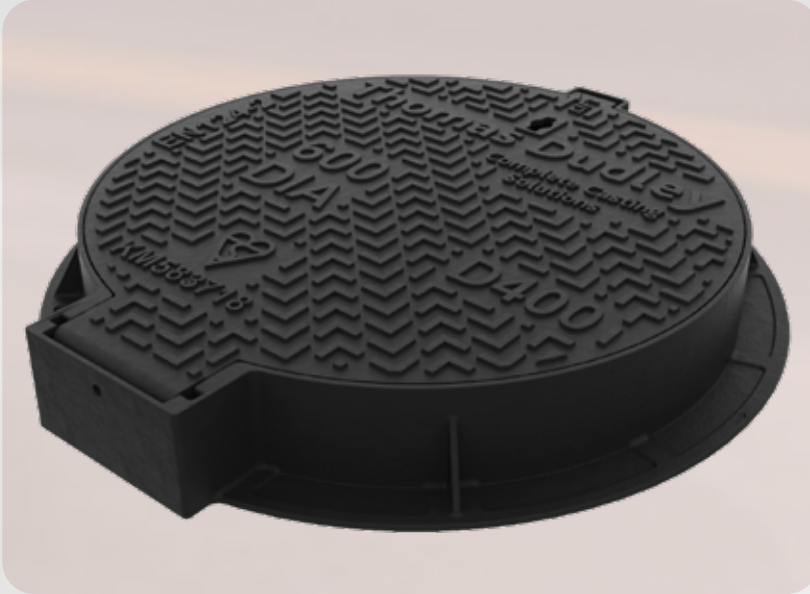

KEY FEATURES



COMPLIES WITH
BS EN 124-2



CERTIFIED
BY BSI



SUITS CLASS
D400 APPLICATIONS



SNAPLOCK
FEATURE

BENEFITS

- ✓ Complies fully with BS EN 124-2:2015 Standard - suitable for intensity of traffic in Class D400 applications
- ✓ Engineered from quality assured ductile iron
- ✓ Unique, slip resistant Thomas Dudley heavy duty drain covers tread pattern
- ✓ One piece Gripfix lid
- ✓ Snap-lock feature for added security
- ✓ Lift out covers for 600 dia, providing 135° hinging giving superior site safety and one man operation
- ✓ Full 360° seal for 600 dia

CLEAR OPENING (A) MM	OVER FRAME (B) MM	DEPTH (C) MM	GRIPFIX	SNAP LOCK	CODE
600 x 450	700 x 550	100	✓		330822
600 dia Circular Flange	768 x 750	100		✓	330945
600 dia Square Flange	767 x 682	100		✓	333015

DOUBLE TRIANGULAR COVERS & FRAMES



FEATURES INC IN THE RANGE



COMPLIES WITH
BS EN 124-2



CERTIFIED
BY BSI



SLIP
RESISTANT



COMPLIES WITH UK
HIGHWAYS AUTHORITY

D400KM DUCTILE IRON HINGED DOUBLE TRIANGULAR COVER & FRAME

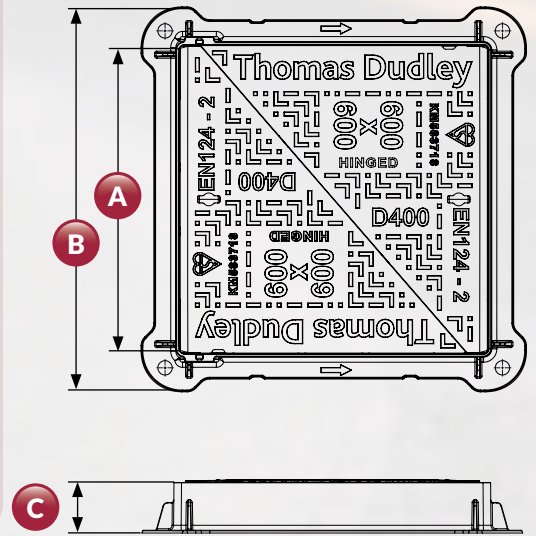

KEY FEATURES



COMPLIES WITH
BS EN 124-2



CERTIFIED
BY BSI



SUITS CLASS
D400 APPLICATIONS



COMPLIES WITH UK
HIGHWAYS AUTHORITY
HA 104/09

CLEAR OPENING (A) MM	OVER FRAME (B) MM	DEPTH (C) MM	CODE
445x280	565x405	100	334582
450x450	600x600	100	332748
600x450	750x600	100	330987
600x600	750x750	100	330823
600x600	750x750	150	330926
675x675	825x825	100	330927
675x675	825x825	150	330928
750x450	602x904	100	333623
750x600	900x750	100	330940
750x750	900x900	100	330929
900x600	1050x750	100	330941
900x900	1050x1050	100	330930

BENEFITS

- ✓ Complies fully with BS EN 124-2:2015 and Highways Authority HA 104/09 Standard - suitable for intensity of traffic in Class D400 applications
- ✓ Engineered from quality assured ductile iron
- ✓ Unique, slip resistant Thomas Dudley heavy duty drain covers tread pattern
- ✓ Hinged as standard
- ✓ Hinged double triangular non-rock cover complying to one man lift manual handling regulations
- ✓ Lift out covers for 450 x 450 and above, providing 135° hinging giving superior site safety and one man operation

D400KM DUCTILE IRON HINGED DOUBLE TRIANGULAR DROP IN COVER & FRAME

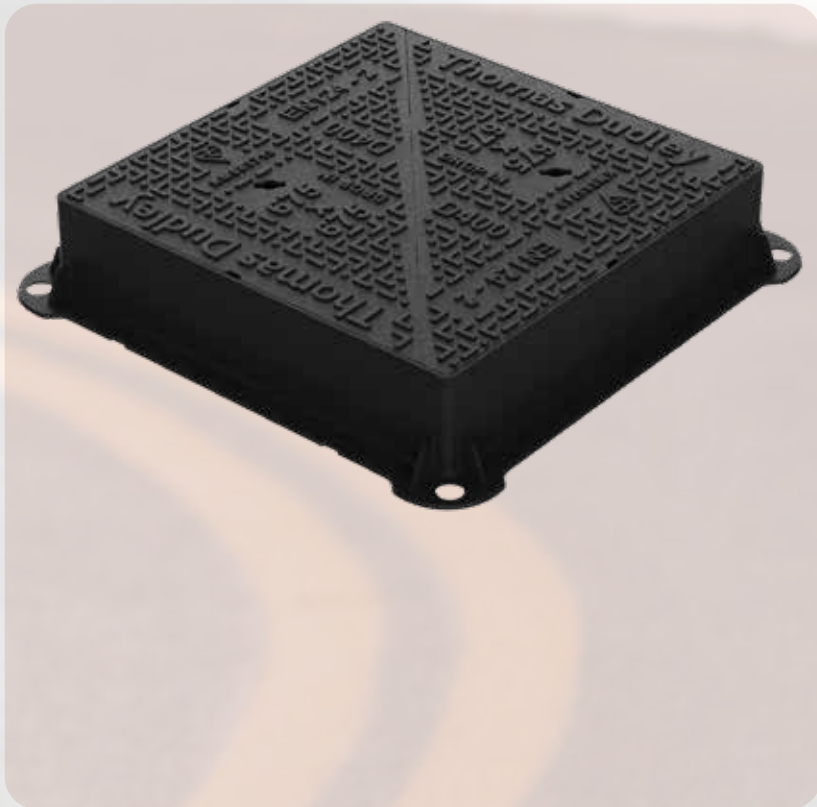

KEY FEATURES



SUITS CLASS
D400 APPLICATIONS

BENEFITS



CLEAR OPENING (A) MM	OVER FRAME (B) MM	DEPTH (C) MM	CODE
675x675	815x815	100	334625
675x675	815x815	150	334621
600x600	740x740	100	334624
600x600	740x740	150	334619

E600KM DUCTILE IRON HINGED DOUBLE TRIANGULAR COVER & FRAME

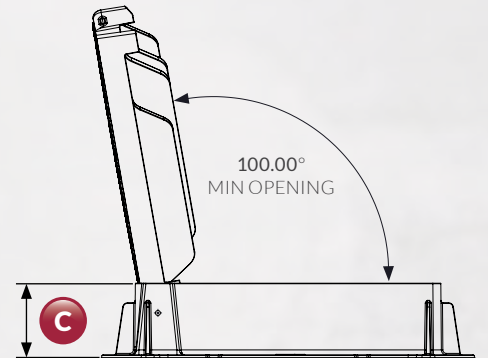
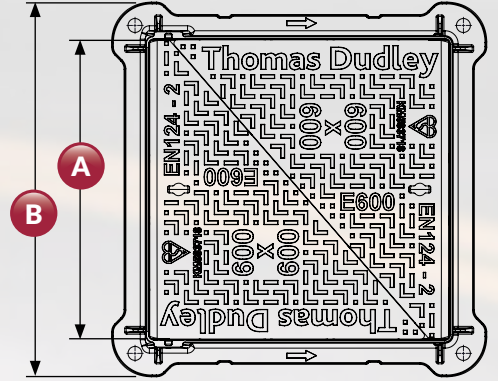
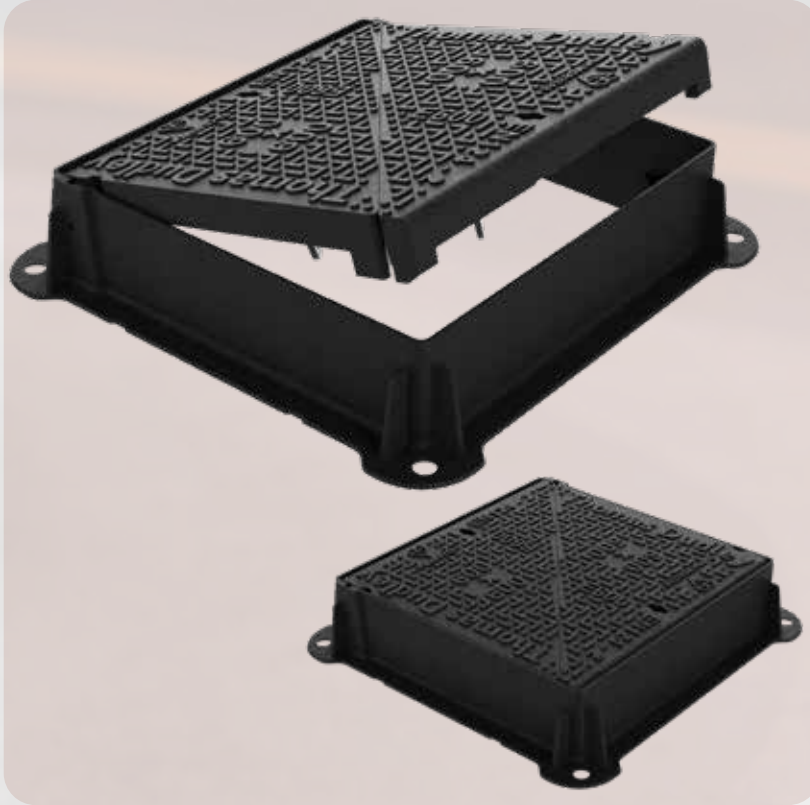

KEY FEATURES



COMPLIES WITH
BS EN 124-2



CERTIFIED
BY BSI



SUITS CLASS
E600 APPLICATIONS



COMPLIES WITH UK
HIGHWAYS AUTHORITY
HA 104/09

BENEFITS

- ✓ Complies fully with BS EN 124-2:2015 and Highways Authority HA 104/09 Standard - suitable for intensity of traffic in Class E600 applications
- ✓ Engineered from quality assured ductile iron
- ✓ Unique, slip resistant Thomas Dudley drain covers tread pattern
- ✓ Hinged Double triangular non-rock cover complying to one man lift manual handling regulations
- ✓ Lift out covers providing 135° hinging giving superior site safety and one man operation

CLEAR OPENING (A) MM	OVER FRAME (B) MM	DEPTH (C) MM	CODE
450x450	600x600	150	334401
600x600	750x750	150	334324
675x675	830x830	150	334325

F900KM DUCTILE IRON HINGED DOUBLE TRIANGULAR COVER & FRAME

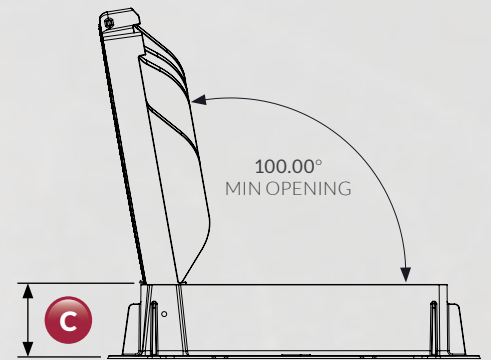
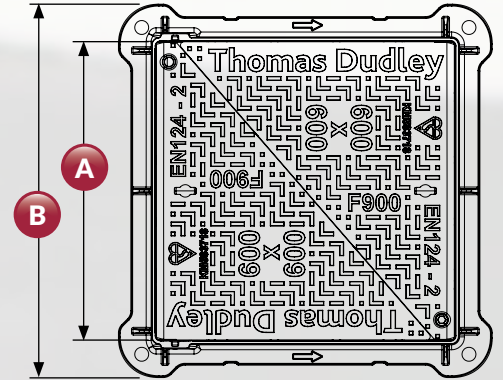
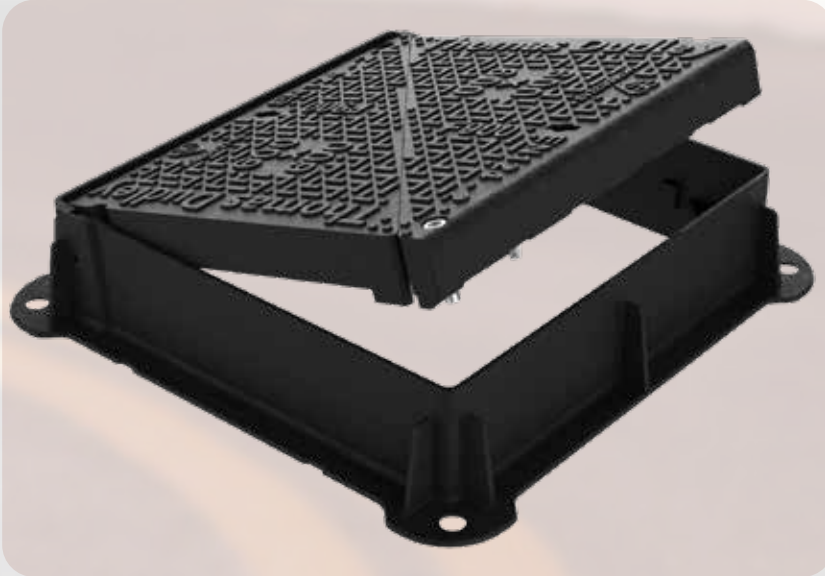

KEY FEATURES



COMPLIES WITH
BS EN 124-2



CERTIFIED
BY BSI



SUITS CLASS
F900 APPLICATIONS



COMPLIES WITH UK
HIGHWAYS AUTHORITY
HA 104/09

BENEFITS

- ✓ Complies fully with BS EN 124-2:2015 and Highways Authority HA 104/09 Standard - suitable for intensity of traffic in Class F900 applications
- ✓ Engineered from quality assured ductile iron
- ✓ Unique, slip resistant Thomas Dudley heavy duty drain covers tread pattern
- ✓ Hinged Double triangular non-rock cover complying to one man lift manual handling regulations
- ✓ Lift out covers providing 135° hinging giving superior site safety and one man operation
- ✓ Other sizes available to order

CLEAR OPENING (A) MM	OVER FRAME (B) MM	DEPTH (C) MM	CODE
450x450	600x600	150	334402
600x600	700x750	150	334275
675x675	830x830	150	334323

MULTI-PART TRIANGULAR COVERS AND FRAMES



FEATURES INC IN THE RANGE



COMPLIES WITH
BS EN 124-2



CERTIFIED
BY BSI



SLIP
RESISTANT



COMPLIES WITH UK
HIGHWAYS AUTHORITY

D400KM DUCTILE IRON HINGED MULTI-PART TRIANGULAR COVER & FRAME

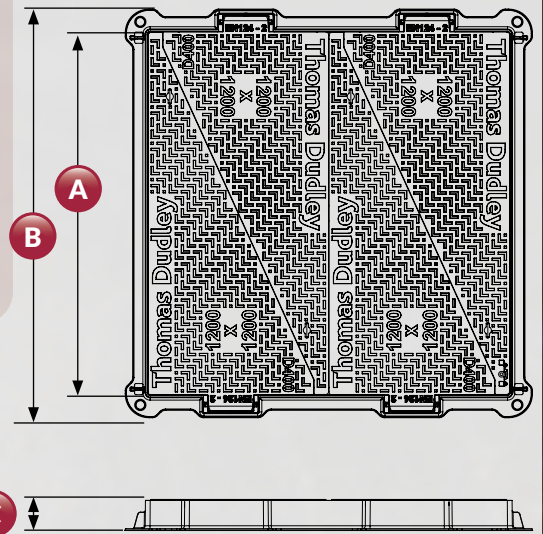
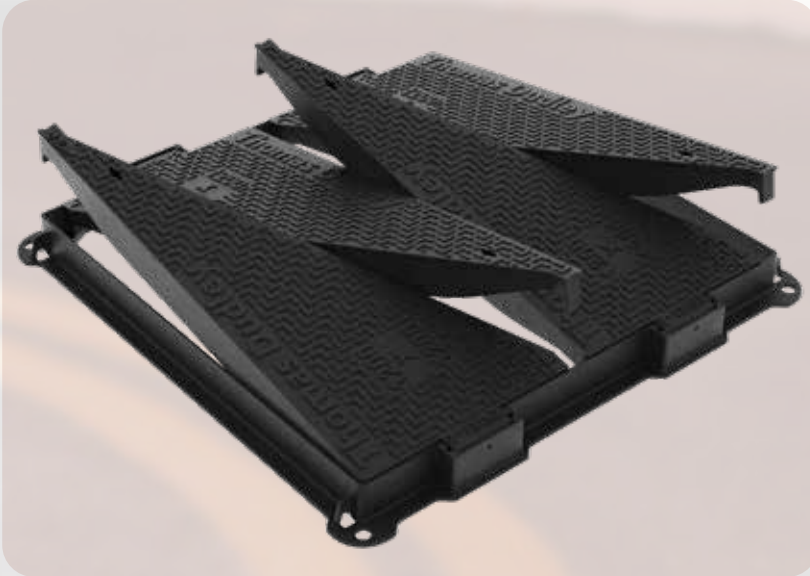

KEY FEATURES



COMPLIES WITH
BS EN 124-2



CERTIFIED
BY BSI



SUITS CLASS
D400 APPLICATIONS



COMPLIES WITH UK
HIGHWAYS AUTHORITY
HA 104/09

BENEFITS

- ✓ Complies fully with BS EN 124-2:2015 and Highways Authority HA 104/09 Standard - suitable for intensity of traffic in Class D400 applications
- ✓ Engineered from quality assured ductile iron
- ✓ Unique, slip resistant Thomas Dudley heavy duty drain covers tread pattern
- ✓ Hinged and lift out as standard
- ✓ Non-rock cover complying to one man lift manual handling regulations, multi leaf
- ✓ Master and Slave with single locking point as standard
- ✓ Other sizes available to order

CLEAR OPENING (A) MM	OVER FRAME (B) MM	DEPTH (C) MM	CODE
1000x1000	1150x1150	100	330931
1200x900	1350x1050	100	330932
1200x1200	1350x1350	100	330933
1220x675	1370x825	100	330942
1220x675	1370x825	150	330943

E600KM DUCTILE IRON HINGED MULTI-PART TRIANGULAR COVER & FRAME

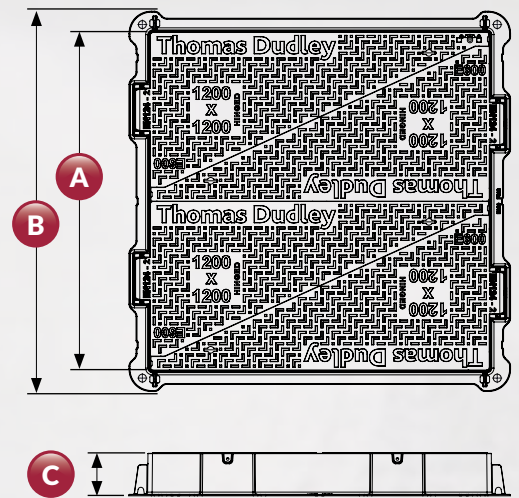
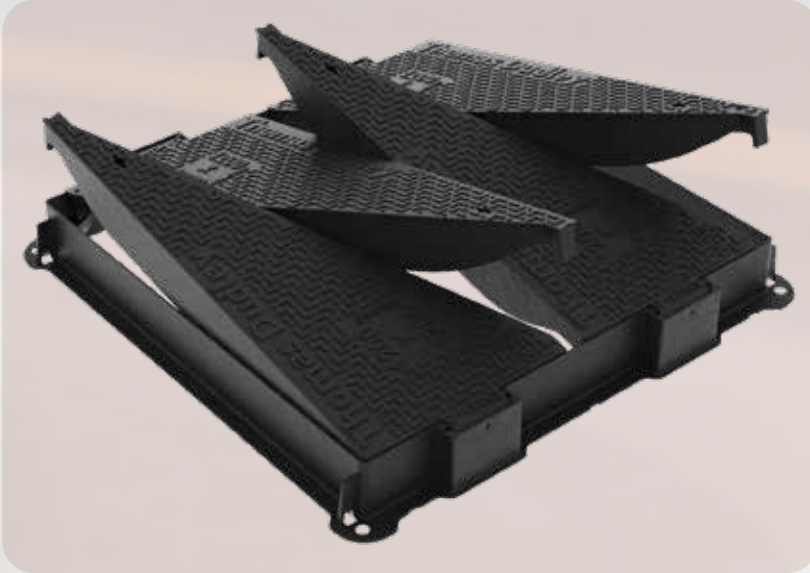

KEY FEATURES



COMPLIES WITH
BS EN 124-2



CERTIFIED
BY BSI



SUITS CLASS
E600 APPLICATIONS



COMPLIES WITH UK
HIGHWAYS AUTHORITY
HA 104/09

BENEFITS

- ✓ Complies fully with BS EN 124-2:2015 and Highways Authority HA 104/09 Standard - suitable for intensity of traffic in Class E600 applications
- ✓ Engineered from quality assured ductile iron
- ✓ Unique, slip resistant Thomas Dudley drain covers tread pattern
- ✓ Hinged Double triangular non-rock cover complying to one man lift manual handling regulations, multi leaf
- ✓ Master and Slave with single locking point as standard
- ✓ Other sizes available to order

CLEAR OPENING (A) MM	OVER FRAME (B) MM	DEPTH (C) MM	CODE
1000x1000	1150x1150	150	334398
1200x900	1350x1050	150	334413
1200x1200	1350x1350	150	333019
1500x750	1650x900	150	333020
1500x900	1650x1050	150	333017
1500x1500	1650x1650	150	332368
1830x675	1980x825	150	332162

F900KM DUCTILE IRON HINGED MULTI-PART TRIANGULAR COVER & FRAME

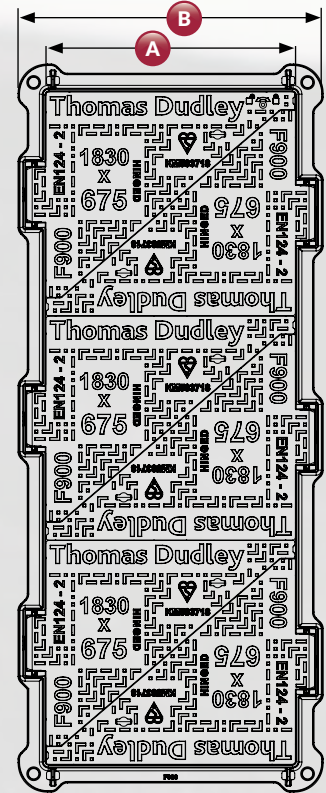
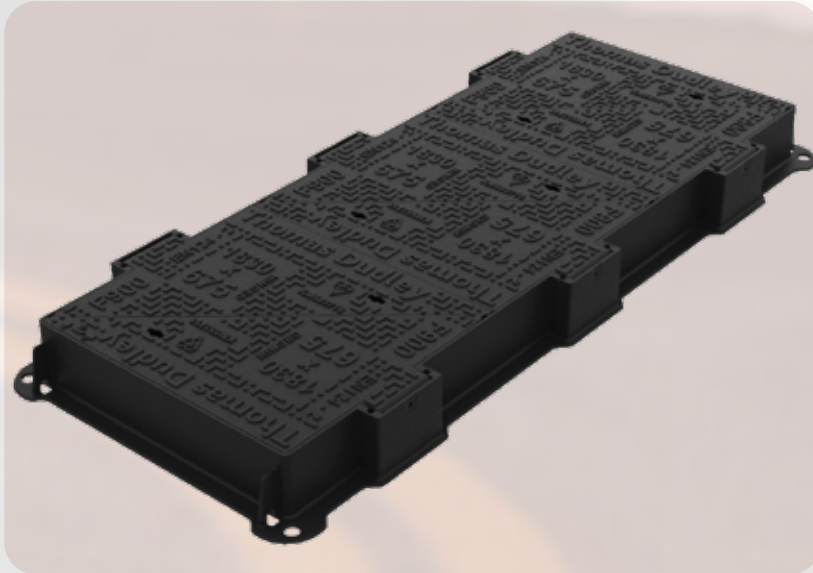

KEY FEATURES



COMPLIES WITH
BS EN 124-2



CERTIFIED
BY BS



SUITS CLASS
F900 APPLICATIONS



COMPLIES WITH UK
HIGHWAYS AUTHORITY
HA 104/09

BENEFITS

- ✓ Complies fully with BS EN 124-2:2015 and Highways Authority HA 104/09 Standard - suitable for intensity of traffic in Class F900 applications
- ✓ Engineered from quality assured ductile iron
- ✓ Unique, slip resistant Thomas Dudley drain covers tread pattern
- ✓ Hinged Double triangular non-rock cover complying to one man lift manual handling regulations, multi leaf
- ✓ Master and Slave with single locking point as standard
- ✓ Other sizes available to order
- ✓ Lift out covers providing 135° hinging giving superior site safety and one man operation

CLEAR OPENING (A) MM	OVER FRAME (B) MM	DEPTH (C) MM	CODE
1000 x 1000	1155 x 1150	150	334399
1200 x 900	1350 x 1055	150	334414
1200 x 1200	1355 x 1350	150	334400
1500 x 900	1650 x 1050	150	TBC
1500 x 1500	1650 x 1650	150	TBC
1830 x 675	1980 x 830	150	334583

MULTI-PART TRIANGULAR COVERS AND FRAMES

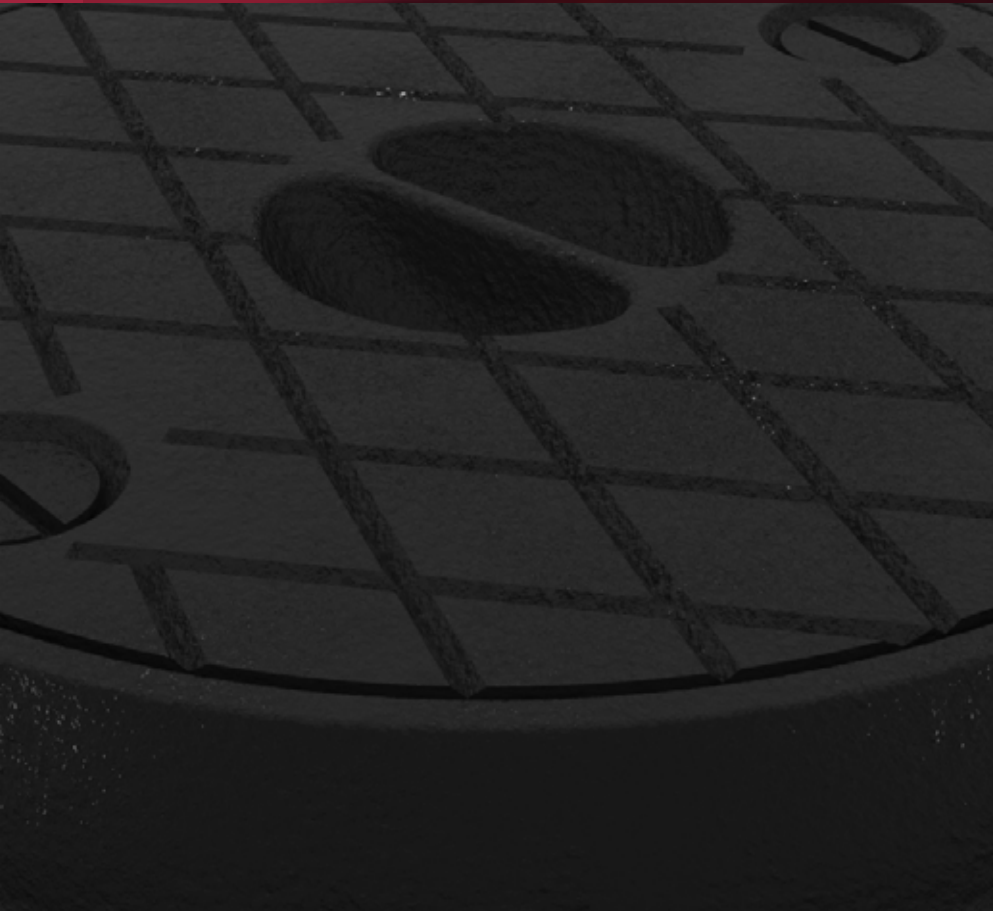

FEATURES INC IN THE RANGE



GULLY GRIDS

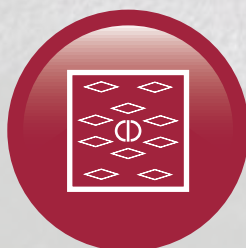

SEALING PLATES

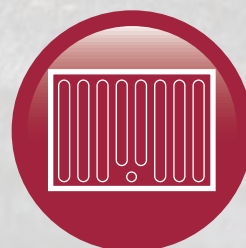

GRATINGS
AND FRAMES



LIFTING TOOLS

D125 SQUARE DISHED PATTERN GULLY GRIDS

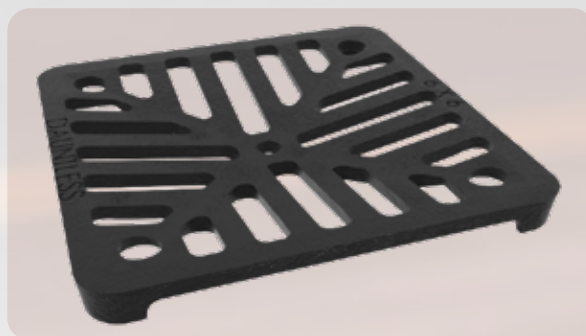

DIMENSION		COATED	GALVANISED	DIMENSION		COATED	GALVANISED
MM	INCHES	CODE	CODE	MM	INCHES	CODE	CODE
102x102x9	4x4x $\frac{3}{8}$	314296	PLEASE ENQUIRE	165x165x13	6 $\frac{1}{2}$ x6 $\frac{1}{2}$ x $\frac{1}{2}$	316946	PLEASE ENQUIRE
114x114x9	4 $\frac{1}{2}$ x4 $\frac{1}{2}$ x $\frac{3}{8}$	314549	318338	178x178x13	7x7x $\frac{1}{2}$	316566	PLEASE ENQUIRE
120x120x13	4 $\frac{3}{4}$ x4 $\frac{3}{4}$ x $\frac{1}{2}$	314964	314378	203x203x13	8x8x $\frac{1}{2}$	316638	318500
127x127x9	5x5x $\frac{3}{8}$	316119	318613	229x229x13	9x9x $\frac{1}{2}$	314781	318238
152x152x6	6x6x $\frac{1}{4}$	313220	315574	254x254x13	10x10x $\frac{1}{2}$	314113	316933
152x152x9	6x6x $\frac{3}{8}$	313124	315421	305x305x13	12x12x $\frac{1}{2}$	313562	319021
152x152x13	6x6x $\frac{1}{2}$	319469	313501	321x321x13	12 $\frac{3}{8}$ x12 $\frac{3}{8}$ x $\frac{1}{2}$	317236	318900

D126 ROUND DISHED PATTERN GULLY GRIDS



DIMENSION		COATED	GALVANISED	DIMENSION		COATED	GALVANISED
MM	INCHES	CODE	CODE	MM	INCHES	CODE	CODE
76 dia. x 9	3x $\frac{3}{8}$	319489	PLEASE ENQUIRE	191 dia. x 9	7 $\frac{1}{2}$ x $\frac{3}{8}$	319451	316001
102 dia. x 9	4x $\frac{3}{8}$	318308	317050	197 dia. x 9	7 $\frac{3}{4}$ x $\frac{3}{8}$	315837	PLEASE ENQUIRE
114 dia. x 9	4 $\frac{1}{2}$ x $\frac{3}{8}$	313172	PLEASE ENQUIRE	203 dia. x 9	8x $\frac{3}{8}$	317052	316369
127 dia. x 9	5x $\frac{3}{8}$	319759	318839	229 dia. x 9	9x $\frac{3}{8}$	314891	317555
140 dia. x 9	5 $\frac{1}{2}$ x $\frac{3}{8}$	316375	318051	254 dia. x 16	10x $\frac{3}{8}$	318136	317685
152 dia. x 9	6x $\frac{3}{8}$	316960	316175	273 dia. x 9	10 $\frac{3}{4}$ x $\frac{3}{8}$	PLEASE ENQUIRE	316032
165 dia. x 9	6 $\frac{1}{2}$ x $\frac{3}{8}$	319232	316889	286 dia. x 9	11 $\frac{1}{4}$ x $\frac{3}{8}$	317657	313369
178 dia. x 9	7x $\frac{3}{8}$	316725	315983	305 dia. x 16	12x $\frac{3}{8}$	315529	316144

D127 ROUND FLAT STRAIGHT BAR PATTERN GULLY GRIDS



DIMENSION		COATED	GALVANISED	DIMENSION		COATED	GALVANISED
MM	INCHES	CODE	CODE	MM	INCHES	CODE	CODE
76 dia. x 9	3 x 3/8	317969	PLEASE ENQUIRE	229 dia. x 13	9 x 1/2	313760	317647
89 dia. x 13	3 1/2 x 1/2	317551	PLEASE ENQUIRE	229 dia. x 25	9 x 1	316874	PLEASE ENQUIRE
102 dia. x 9	4 x 3/8	315218	313384	267 dia. x 25	10 1/2 x 1	316268	317585
114 dia. x 9	4 1/2 x 3/8	PLEASE ENQUIRE	315675	279 dia. x 13	11 x 1/2	318530	PLEASE ENQUIRE
127 dia. x 9	5 x 3/8	318266	317091	286 dia. x 16	11 1/4 x 3/8	PLEASE ENQUIRE	316527
152 dia. x 9	6 x 3/8	314580	314426	286 dia. x 25	11 1/4 x 1	313130	PLEASE ENQUIRE
178 dia. x 9	7 x 3/8	313999	316522	305 dia. x 16	12 x 3/8	318570	316122
191 dia. x 9	7 1/2 x 3/8	315029	316928	305 dia. x 25	12 x 1	PLEASE ENQUIRE	315411
197 dia. x 9	7 3/4 x 3/8	313628	PLEASE ENQUIRE	368 dia. x 25	14 1/2 x 1	314535	315232
197 dia. x 22	7 3/4 x 1/8	PLEASE ENQUIRE	318859	381 dia. x 25	15 x 1	PLEASE ENQUIRE	318990
203 dia. x 9	8 x 3/8	PLEASE ENQUIRE	317300				

D129 FLAT COBWEB GULLY GRIDS

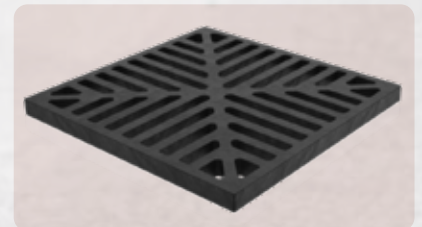

DIMENSION		COATED
MM	INCHES	CODE
381 x 381 x 25	15 x 15 x 1	313884

D130 SQUARE AND RECTANGULAR FLAT STRAIGHT BAR PATTERN GULLY GRIDS

DIMENSION		COATED	GALVANISED	DIMENSION		COATED	GALVANISED
MM	INCHES	CODE	CODE	MM	INCHES	CODE	CODE
102 x 102 x 9	4 x 4 x 3/8	318047	314492	229 x 229 x 13	9 x 9 x 1/2	PLEASE ENQUIRE	313151
127 x 127 x 13	5 x 5 x 1/2	318884	317611	229 x 229 x 25	9 x 9 x 1	319642	319378
152 x 152 x 9	6 x 6 x 3/8	314606	314325	254 x 152 x 13	10 x 6 x 1/2	317081	319086
152 x 152 x 25	6 x 6 x 1	PLEASE ENQUIRE	317949	254 x 254 x 13	10 x 10 x 1/2	318270	317342
178 x 178 x 13	7 x 7 x 1/2	PLEASE ENQUIRE	316762	305 x 305 x 13	12 x 12 x 1/2	PLEASE ENQUIRE	315816
203 x 203 x 13	8 x 8 x 1/2	314808	314174				

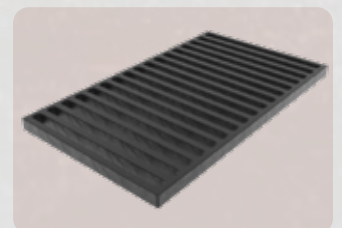

D131 ROUND FLAT STRAIGHT BAR GULLY GRIDS

DIMENSION		COATED	GALVANISED
MM	INCHES	CODE	CODE
178 dia. x 9	7 x 3/8	318245	PLEASE ENQUIRE

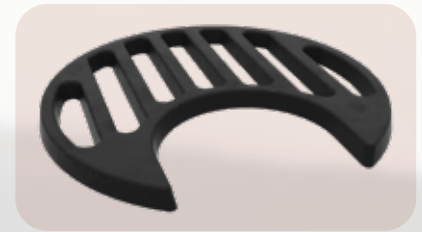

D105 CIRCULAR SEALING PLATES AND FRAMES

DIMENSION		COATED	GALVANISED
MM	INCHES	CODE	CODE
114x25	4 1/2 x 1	318234	PLEASE ENQUIRE
140x25	5 1/2 x 1	318258	PLEASE ENQUIRE
191x25	7 1/2 x 1	315007	314034
273x25	10 3/4 x 1	317213	318457



D106 SQUARE AND RECTANGULAR SEALING PLATES AND FRAMES

DIMENSION		COATED	GALVANISED
MM	INCHES	CODE	CODE
120x120x25	4 3/4 x 4 3/4 x 1	PLEASE ENQUIRE	319611
152x152x25	6 x 6 x 1	318071	316523
229x229x25	9 x 9 x 1	313547	319284
254x125x25	10 x 6 x 1	PLEASE ENQUIRE	PLEASE ENQUIRE
305x305x25	12 x 12 x 1	313443	318787

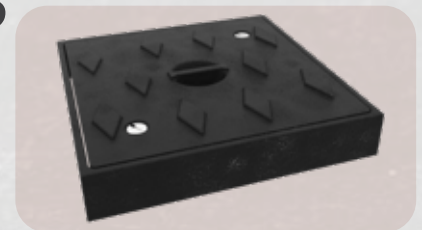

D106D OVAL SEALING PLATES AND FRAMES

DIMENSION		COATED	GALVANISED
MM	INCHES	CODE	CODE
298 x 143 x 25	11 3/4 x 5 5/8 x 1	313975	314033



D170 GARDEN GRATINGS AND FRAMES

DIMENSION		COATED	GALVANISED
MM	INCHES	CODE	CODE
229 x 229 x 35	9 x 9 x 1 1/4	317438	315613

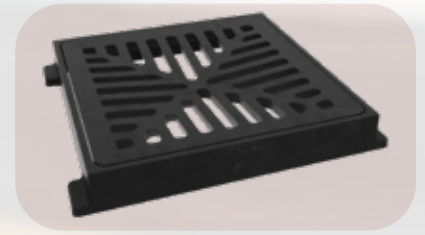

D172 ROUND GULLY GRATINGS AND FRAMES

DIMENSION		COATED	GALVANISED
MM	INCHES	CODE	CODE
140 x 25	5 1/2 x 1	319513	314619
197 x 25	7 3/4 x 1	314067	316385
273 x 35	10 3/4 x 1 1/4	315337	318187
368 x 35	14 1/2 x 1 1/4	314515	318578



D173 SQUARE GULLY GRATINGS AND FRAMES

DIMENSION		COATED	GALVANISED
MM	INCHES	CODE	CODE
152 x 152 x 25	6 x 6 x 1	314138	319347
229 x 229 x 25	9 x 9 x 1	315324	319586
229 x 229 x 38	9 x 9 x 1 1/2	318510	315489
254 x 254 x 38	10 x 10 x 1 1/2	316277	318825
305 x 305 x 38	12 x 12 x 1 1/2	316120	316597



PLASTIC DRAIN GRIDS

DIMENSION		
MM	INCHES	CODE
152 x 152	6 x 6	314607

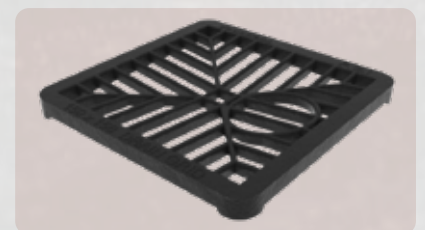

HYDRAFOLD MANHOLE LIFTING TOOLS (PAINTED FINISH)

DESCRIPTION	CODE
HYDRAFOLD LIFTING TOOL	323293
HYDRAFOLD 4 HEAD KEYWHEEL	319826



HYDRA LIFTING TOOL (PAINTED FINISH)

DESCRIPTION	CODE
530MM LONG HANDLE	313100

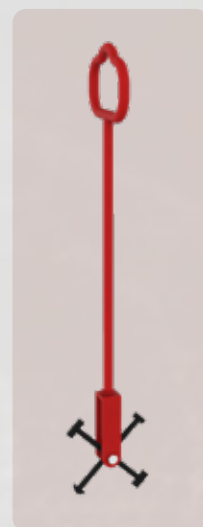

LIFTING KEYS LIGHT, MEDIUM AND HEAVY DUTY



DESCRIPTION	LENGTH MM	KEYHOLE SIZE MM	CODE
HD3 DUCTILE HEAVY DUTY	300	36x8	317006
HD2 STEEL HEAVY DUTY	442	37x10	315456
M1 DUCTILE MEDIUM DUTY	125	29x9	317796
LD3 GREY IRON LIGHT DUTY	75	24x13	314350
LD4 GREY IRON LIGHT DUTY	71	23x9	317895

SURFACE BOXES



FEATURES INC IN THE RANGE



SURFACE
BOXES



STOP TAP
BOXES



BOUNDARY
BOXES



VARIOUS BADGING
AVAILABLE

GRIPFIX 6270 6274 SURFACE BOXES

GRADE	CLEAR OPENING MM	OVER FRAME MM	DEPTH MM	CODE
D400 (6274)	380x230	536x385	100	PLEASE ENQUIRE
D400 (6270)	380x230	536x385	125	PLEASE ENQUIRE

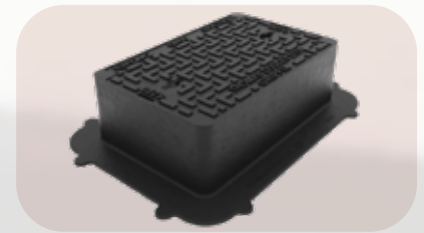

GRIPFIX 135AN, 225AN, 300AN COATED SURFACE BOXES

GRADE	CLEAR OPENING MM	OVER FRAME MM	DEPTH MM	CODE
135AN	150x150	245x245	100	PLEASE ENQUIRE
135AN (SLOTTED)	150x150	245x245	100	PLEASE ENQUIRE
225AN	225x225	304x304	100	PLEASE ENQUIRE
300AN	300x300	380x380	100	PLEASE ENQUIRE



100B2S MEDIUM DUTY COATED SURFACE BOXES

CLEAR OPENING MM	OVER FRAME MM	DEPTH MM	CODE
127x80	180x180	75	319627



6150 6153 BOUNDARY BOXES

GRADE	CLEAR OPENING MM	OVER FRAME MM	DEPTH MM	SPIGOT DEPTH MM	CODE
B (6150/135)	165x150	240x240	60	30	PLEASE ENQUIRE
B (6150/150)	180x160	240x240	60	30	PLEASE ENQUIRE
B (6150/180)	220x200	240x240	60	45	PLEASE ENQUIRE
B (6153/190)	210x200	275x275	75	-	PLEASE ENQUIRE



TYPE A COATED SURFACE BOXES

CLEAR OPENING MM	OVER FRAME MM	DEPTH MM	CODE
152x127 (BADGED WITH W)	202x170	75	314996
152x127 (BADGED WITH GAS)	202x170	75	316034



D6110 STOP TAP BOXES

DIMENSION			DEPTH		COATED
PATTERN	MM	INCHES	MM	INCHES	CODE
HINGED LID	114x114	4½x4½x3	76	3	317269
HINGED LID	127x127	5x5x4	102	4	313223
HINGED LID	152x152	6x6x3	76	3	319994
HINGED & LOCKING LID	152x152	6x6x3	76	3	326111
HINGED BOX	210x200		75		319998
HINGED LID	305x305	12x12x4	102	4	316363

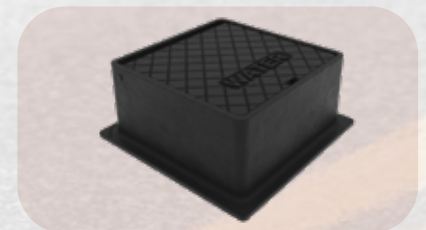

100C1H PLASTIC SURFACE BOXES

DIMENSION			DEPTH	COATED
PATTERN	MM	INCHES	MM	CODE
"W" BLACK LID	135x119	5 ¼x4 1/16	75	313629



ALUMINIUM DOUBLE SEALED DS-LINE

RECESSED MANHOLE COVERS

The Alucover DS-Line range are double sealed, featuring a highly aesthetic extruded aluminium construction manufactured to BS:EN124 standard.

The unique double seal allows for an additional odour barrier, elasticity to avoid tension between the recessed cover and frame, and the prevention of dirt between the cover and frame for wasy removal.



HIGH GRADE
EPDM SEAL



COMPLIES WITH
BS EN 124-2



SELF-SECURED



KEY FEATURES

- ✓ Extruded aluminium frame and easy to open
- ✓ The cover is odour and waterproof
- ✓ Recommended for exterior applications
- ✓ Lifting keys and reinforcement mesh
- ✓ Featuring a high-grade EPDM seal and a "T-rubber" seal on the side of the frame
- ✓ Self Secured by the weight of the infill
- ✓ Lifting holes covered with plastic caps

DOUBLE SEALED ALUMINIUM RECESSED COVER

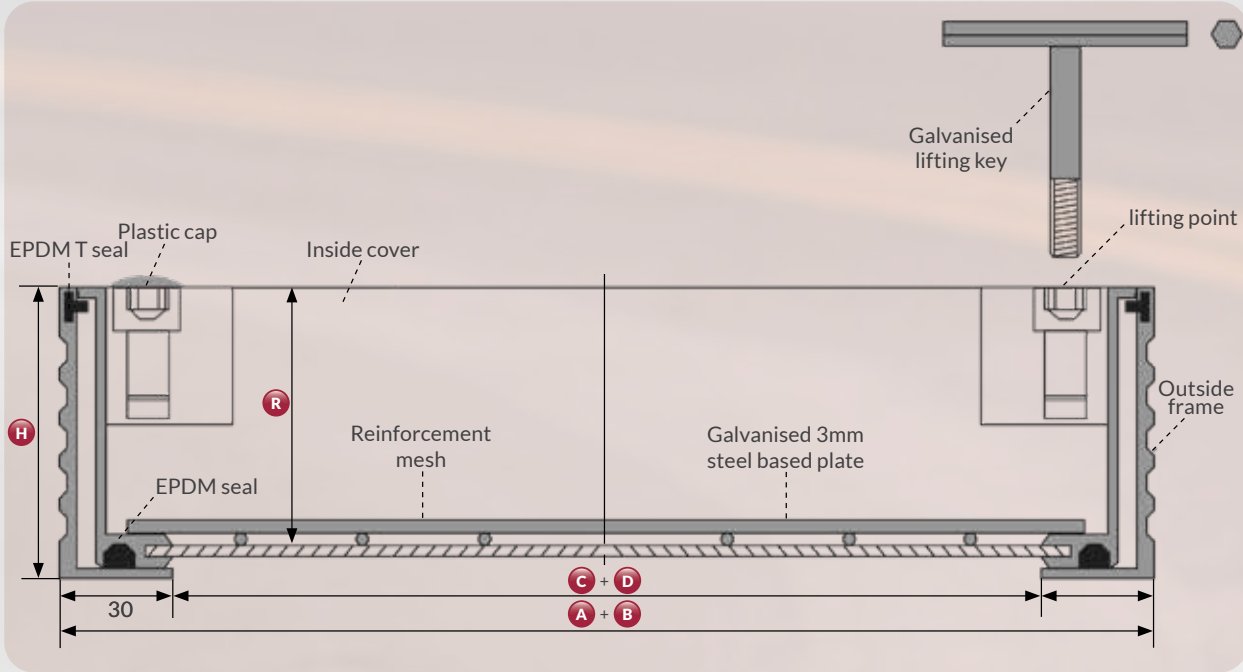

OVERALL SIZE A x B (MM)	CLEAR OPENING C x D (MM)	OVERALL DEPTH H (MM)	IN TRAY DEPTH R (MM)	CODE
360 x 360	300 x 300	60	48	370164
510 x 510	450 x 450	60	48	370165
660 x 510	600 x 450	60	48	370166
660 x 660	600 x 600	60	48	370167
810 x 610	750 x 600	60	48	370168
810 x 810	750 x 750	60	48	370169
960 x 660	900 x 600	60	48	370170
960 x 960	900 x 900	60	48	370171
1060 x 1060	1000 x 1000	60	48	370172
360 x 360	300 x 300	80	68	370173
510 x 510	450 x 450	80	68	370174
660 x 510	600 x 450	80	68	370175
660 x 660	600 x 600	80	68	370176
810 x 660	750 x 600	80	68	370177
810 x 810	750 x 750	80	68	370178
960 x 660	900 x 600	80	68	370179
960 x 960	900 x 900	80	68	370180
1060 x 1060	1000 x 1000	80	68	370181

Also available in 100mm and 40mm depth plus bespoke sizes upon request

WEIGHT LOADING



Load Class Max			40kN	75kN
DS - Line - 60	✓	✓	✓	
DS - Line - 80	✓	✓	✓	
DS - Line - 100	✓	✓	✓	
TSL - Pro - Line - 60	✓	✓	✓	✓
TSL - Pro - Line - 80	✓	✓	✓	✓
TSL - Pro - Line - 100	✓	✓	✓	✓

ALUMINIUM TRIPLE SEALED TSL-PRO-LINE

RECESSED MANHOLE COVERS

The Alucover TSL-Pro-Line range are triple sealed and locking, featuring a highly aesthetic extruded aluminium construction. They are loory load bearing and manufactured to BS:EN124 standard.

The unique triple seal; two at the base and a "T-rubber" seal allows for an additional odour barrier, elasticity to avoid tension between the recessed cover and frame, and the prevention of dirt between the cover and frame for easy removal.



COVER IS ODOUR
& WATERPROOF



COMPLIES WITH
BS EN 124-2



ADDITIONAL
SCREWLOCK



KEY FEATURES

- ✓ Extruded aluminium frame and easy to open
- ✓ The cover is odour and waterproof
- ✓ Recommended for interior and exterior applications
- ✓ Lifting keys and reinforcement mesh
- ✓ Featuring a high-grade EPDM seal and a "T-rubber" seal on the side of the frame
- ✓ Locked with stainless steel socket head screws
- ✓ Lifting holes covered with plastic caps

TRIPLE SEALED ALUMINIUM RECESSED COVER

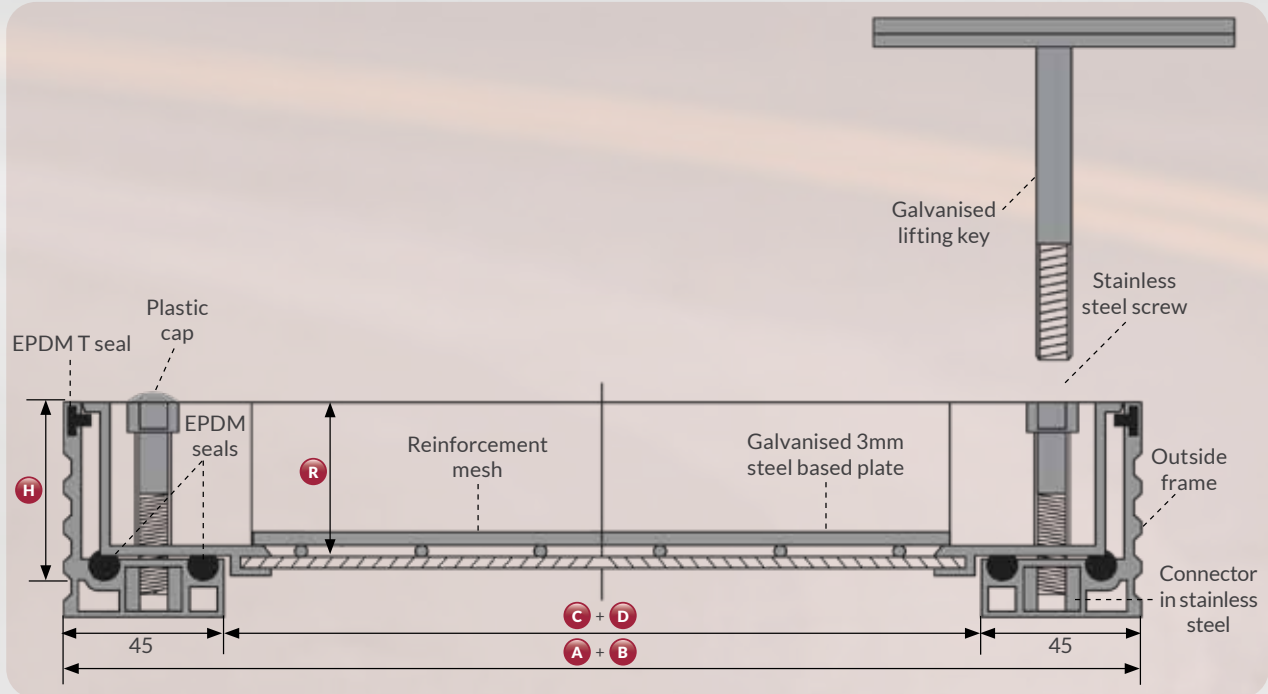

OVERALL SIZE A x B (MM)	CLEAR OPENING C x D (MM)	OVERALL DEPTH H (MM)	IN TRAY DEPTH R (MM)	CODE
240 x 240	150 x 150	60	41	370186
390 x 390	300 x 300	60	41	370182
540 x 540	450 x 450	60	41	370183
690 x 540	600 x 450	60	41	370184
690 x 690	600 x 600	60	41	370185
840 x 690	750 x 600	60	41	370192
840 x 840	750 x 750	60	41	370193
990 x 690	900 x 600	60	41	370194
990 x 990	900 x 900	60	41	370195
1090 x 1090	1000 x 1000	60	41	370196
390 x 390	300 x 300	80	61	370197
490 x 490	400 x 400	80	61	370198
590 x 590	500 x 500	80	61	370199
690 x 690	600 x 600	80	61	370200
790 x 790	700 x 700	80	61	370201
890 x 890	800 x 800	80	61	370202
990 x 990	900 x 900	80	61	370203
1090 x 1090	1000 x 1000	80	61	370204

Also available in 100mm and 40mm depth plus bespoke sizes upon request

WEIGHT LOADING



Load Class Max			40kN	75kN
DS - Line - 60	✓	✓	✓	
DS - Line - 80	✓	✓	✓	
DS - Line - 100	✓	✓	✓	
TSL - Pro - Line - 60	✓	✓	✓	✓
TSL - Pro - Line - 80	✓	✓	✓	✓
TSL - Pro - Line - 100	✓	✓	✓	✓

CALL 0121 521 2503

REQUEST A QUOTE

Requesting a quotation from us for heavy duty manhole covers and heavy duty drain covers couldn't be easier. Simply visit www.dudleyfoundryproducts.co.uk/request-quote and fill out the form.

Enquiries

Please call  0121 521 2503 or email @foundrysales@thomasdudley.co.uk

CALL 0121 521 2503



Thomas Dudley Foundry

Complete casting solutions

✉ Thomas Dudley Foundry Ltd. 295 Birmingham New Road, Dudley, West Midlands, DY1 4SJ

☎ 0121 521 2503 @foundrysales@thomasdudley.co.uk

📱 @TDLFoundry 📺 Thomas Dudley Foundry Ltd

🌐 www.thomasdudleycastings.co.uk

THOMAS DUDLEY RESERVES THE RIGHT TO ALTER PRODUCT SPECIFICATIONS